

Title	Air-Enhanced Self-compactability of Fresh Concrete
Author(s)	ATTACHAIYAWUTH, Anuwat
Citation	高知工科大学, 博士論文.
Date of issue	2015-09
URL	http://hdl.handle.net/10173/1322
Rights	
Text version	ETD



Kochi, JAPAN

<http://kutarr.lib.kochi-tech.ac.jp/dspace/>

Air-enhanced self-compactability of fresh concrete

ATTACHAIYAWUTH Anuwat

A dissertation submitted to
Kochi University of Technology
in partial fulfillment of the requirements for the degree of
Doctor of Engineering

Department of Infrastructures System Engineering
Graduate School of Engineering
Kochi University of Technology
Kochi, Japan

August 2015

Air-enhanced self-compactability of fresh concrete

ATTACHAIYAWUTH Anuwat

Abstract

The purpose of this study is to develop a self-compacting concrete with lower cement concrete. So that the material cost may be similar to that of conventional concrete. For that purpose, higher water to cement ratio and higher fine aggregate content in mortar were indispensable. The author made use of entrained air for reducing the friction between the solid particles in the concrete during its deformation at fresh stage.

The enhancement of self-compactability by entrained air is ball bearing effect. Entrained air produced by different type of air entraining agent differently resulted in effectiveness of ball bearing effect. Furthermore, stability of entrained air was also important because air volume directly affected the reduction friction. Accordingly, improvement of stability has to be taken into account.

In order to improve self-compactability of SSC and stability of entrained air simultaneously, Alternative mixing method called “water dividing mixing method” was introduced. According to the effective improvement of self-compactability and stability of entrained air, fine aggregate amount in concrete could be increased which resulted in the automatic reduction in cement content in mix proportions. Finally, self-compacting concrete with low cement content by employing entrained air called Air-enhanced self-compacting concrete (airSCC) was developed.

The effectiveness of ball bearing effect significantly related to total surface of entrained bubbles. By considering the same air content, high total surface area was produced by water dividing mixing method with excessive dosage of air entraining agent because of large amount of small bubbles. Total surface area of entrained bubbles was also major factors on level of self-compactability of airSCC due to the results verified with concrete experiment that filling height of concrete effectively improved by increasing total surface area.

Acknowledgements

I would first of all want to express my sincere thanks to my supervisor, Professor Masahiro Ouchi for giving me opportunity to do research in Special Scholarship Program of Kochi University of Technology and for his kindly advising on my research work. His support, advices, detailed comments contributed both to my research skills and professional skills in general. This research would not have been completed without his support that I have always received. I am most grateful to all member of my research supervising committee, Prof. Hiroshi Shima, Prof. Yoshiro Kai, Prof. Seigo Nasu and Associate Prof. Takashi Goso for their valuable comments, advices and suggestions about all important points that have to be considered in my research. Furthermore I really appreciate and respect Professor Hajime Okamura for establishing Kochi University of Technology and of course for inventing Self-Compacting Concrete 25 years ago which is the material used in my research. Because of him, I tried my best to be Ph.D. student at Kochi University of Technology in order to obtain experiences in research and technology especially in concrete engineering field from Japan.

I gratefully appreciate Assistant Prof. Withit Pansuk for inspiring me to try to be Ph.D. student and for all contributions since I was his master student at Chulalongkorn University, Thailand until now. Also Prof. Chai Jaturapitakkul, former head of Civil Engineering Department, KMUTT who inspired me to continue studying master and Ph.D. since I was undergraduate student. I really appreciate Associate Prof. Boonchai Stitmannathum, Vice President, Chulalongkorn University who is my motivation for being good teacher with excellent teaching and explanation performance. I am grateful for Mr. Hideo Miyazi for very useful instructions on my experiment and also for experiences in daily life in Kochi. I would like to thank to all concrete laboratory members for doing concrete experiment which directly related to my research.

My gratitude extends to all members of Kochi Kita Rotary family for Rotary-Yoneyama scholarship 2014-2015, and especially Mr. Kakemizu Yoichiro and Mr. Kenichi Masaki for their kind supports in Rotary society. I would like to thank those whose names are not mentioned but have greatly encouraged me until this research has been completed.

Finally, I would like to heartfelt acknowledge to my parents, sister, brother and my friends for the encouragement that I have always received during 3 years in Japan. I would like to dedicate this research to my father, mother, sister and brother.

TABLE OF CONTENTS

	Page No.
ABSTRACT.....	i
ACKNOWLEDGEMENTS.....	ii
TABLE OF CONTENTS.....	iii
LIST OF TABLES.....	vi
LIST OF FIGURE.....	iii
CHAPTER 1: INTRODUCTION.....	1
1.1 Necessity for reduction in unit cost of self-compacting concrete.....	1
1.2 Trial for reduction in unit cost with the increase in W/C and using viscosity agent	3
1.2.1 Purpose of reduction in friction.....	3
1.2.2 Convenience of mortar experiment.....	4
1.2.3 Evaluation method for degree of friction in mortar	5
1.2.4 Effect of water content on reduction in friction in mortar.....	8
1.2.5 Effect of viscosity modifying agent on reduction in friction in mortar.....	10
1.3 Purpose of this research	12
1.3.1 Enhancement of self-compactability with entrained air.....	14
1.3.2 Ball bearing effect by entrained air in mortar.....	15
1.4 Outline of research.....	16
CHAPTER 2: MITIGATION IN FRICTION WITH HIGHER AIR CONTENT ENTRAINED BY SIMPLE MIXING METHOD	18
2.1 Introduction	18
2.2 Mitigation of friction in mortar by entrained air.....	18
2.3 Stability of entrained air in	24

2.4	Summary.....	25
-----	--------------	----

CHAPTER 3: AIR-ENHANCED SELF-COMPACTABILITY OF FRESH CONCRETE WITH AN EFFECTIVE MIXING PROCEDURE.....26

3.1	Introduction	26
3.2	Outline of water dividing mixing method with Last adding AE mixing method for mortar experiment	26
3.3	Materials used and parameters set up for mortar experiment	27
3.4	Dosage of air entraining agent needed due to different mixing method	29
3.5	Results of flowability of mortar by different mixing method.....	30
3.6	Variation of degree of interaction between model coarse aggregate and mortar ($1-R_{mb}/R_m$) by entrained air with different mixing method	32
3.7	Effect of excessive dosage of air entraining agent on ($1-R_{mb}/R_m$).....	34
3.8	Verification of results of mortar with concrete experiment	36
	3.8.1 Initial air content.....	38
	3.8.2 Stability of air bubbles.....	39
	3.8.3 Self-compactability test of fresh concrete.....	41
	3.8.4 Mix proportion of Air-enhanced self-compacting concrete (AirSCC)	42
3.9	Summary.....	45

CHAPTER 4: EFFECT OF TOTAL SURFACE AREA OF ENTRAINED AIR ON REDUCTION IN FRICTION.....46

4.1	Introduction	46
4.2	Air loss in mortar during hardening.....	50
4.3	Bubbles size distribution in mortar specimens.....	50
4.4	Rate of reduction in funnel speed of mortar with glass beads (R_{mb}) due to the presence of entrained air.....	55
4.5	Mechanism of mixing method and the presence of entrained air on enhancement in flowability of mortar.....	59

4.6	Bubbles size distribution of entrained bubbles in concrete specimens.....	65
4.7	Total surface area of entrained bubbles in concrete specimens.....	65
4.8	Summary.....	69
CHAPTER 5: CONCLUSIONS.....		71
REFERENCES.....		72

LIST OF TABLES

Table 1.1	Materials used for series of studying effect of s/m	8
Table 1.2	Parameters set up to study effect of W/C on $(I-R_{mb}/R_m)$	8
Table 1.3	Parameters set up for series studying of effect of VMA	10
Table 2.1	Materials used for series of studying effect of entrained air on $(I-R_{mb}/R_m)$	18
Table 2.2	Target mix proportions for studying ball bearing effect by entrained air.....	19
Table 2.3	Mix proportions using conventional type of superplasticizer.....	20
Table 2.4	Mix proportions using new type of superplasticizer.....	20
Table 3.1	Materials in used for test on effect of mixing method in terms of $(I-R_{mb}/R_m)$..	28
Table 3.2	Mix proportions of mortar.....	29
Table 3.3	Mix proportions of mortar for studying effect of dosage of AE.....	35
Table 3.4	Mix proportions of concrete.....	38
Table 3.5	Designed parameters of conventional SCC and AirSCC.....	43
Table 3.6	Mix proportion of conventional SCC and AirSCC.....	43
Table 4.1	Mix proportion of mortar specimens for LTM.....	50

LIST OF FIGURES

Fig. 1.1	Materials used for series of studying effect of s/m	1
Fig. 1.2	Internal friction increased due to the increase in sand particles.....	3
Fig. 1.3	Shear resistance of mortar (τ) in accordance with normal stress (σ).....	4
Fig. 1.4	Standard box test for SCC	4
Fig. 1.5	Mixing procedure of mortar experiment	5
Fig. 1.6	Mortar flow test [4].....	6
Fig. 1.7	Mortar funnel test [4].....	6
Fig. 1.8	The increase in filling height of concrete box test due to the reduction in $(I-R_{mb}/R_m)$ [4].....	7
Fig. 1.9	Reduction in friction due to high amount of free water	9
Fig. 1.10	Chemical structure of Welan gum [6].....	10
Fig. 1.11	Internal friction decreased in mortar with moderate W/C	11
Fig. 1.12	Concept of the development of airSCC	13

Fig. 1.13	Unit volume of materials in normal concrete, SCC and AirSCC	14
Fig. 1.14	Internal friction apparently decreased in mortar with AE 3.....	15
Fig. 1.15	Ball bearing effect by entrained air in mortar [4].....	16
Fig. 1.16	Structure of research	17
Fig. 2.1	Adjustment of volume of glass beads in accordance with volume of air.....	19
Fig. 2.2	Degree of mitigation in friction by ball bearing effect of mortar using conventional type of superplasticizer	21
Fig. 2.3	Degree of mitigation in friction by ball bearing effect of mortar using new type of superplasticizer	22
Fig. 2.4	The reduction in $(I-R_{mb}/R_m)$ by entrained air, comparing to mix without AE.	24
Fig. 2.5	Low stability of entrained air	24
Fig. 3.1	Water dividing mixing method for mortar	27
Fig. 3.2	Last adding AE mixing method for mortar	27
Fig. 3.3	Excessive dosage of AE is necessary for new method with new type of superplasticizer	29
Fig. 3.4	Reduction of flowability due to the presence of entrained in mortar using conventional superplasticizer	31
Fig. 3.5	Reduction of flowability due to the presence of entrained in mortar using new- type superplasticizer	32
Fig. 3.6	The increase in $(I-R_{mb}/R_m)$ due to the presence of entrained air in mortar using conventional superplasticizer	33
Fig. 3.7	The reduction in $(I-R_{mb}/R_m)$ due to the presence of entrained air in mortar using new-type superplasticizer	34
Fig. 3.8	Excessive dosage of AE was necessary to produce target air content for water dividing method	35
Fig. 3.9	$(I-R_{mb}/R_m)$ decreased due to the increase in AE dosage in spite of similar air content	36
Fig. 3.10	Water dividing mixing method for concrete	37
Fig. 3.11	Last adding AE mixing method for concrete	37
Fig. 3.12	Sufficient dosage of AE for producing target air content in mortar and concrete	39

Fig. 3.13	Stability of entrained air improved by adding excessive dosage of AE	40
Fig. 3.14	Self-compactability improved by new mixing method	41
Fig. 3.15	Self-compactability test of fresh concrete	42
Fig. 3.16	Unit cost of AirSCC is slightly higher than that of normal concrete	44
Fig. 3.17	The sufficient compressive strength of AirSCC with air content of 10%.....	44
Fig. 4.1	High total surface area of bubbles results in low reduction rate of R_{mb}	46
Fig. 4.2	Linear Traverse Machine.....	47
Fig. 4.3	Graph for estimating the Spacing factor (\bar{L}).....	48
Fig. 4.4	Preparation of specimens for LTM.....	49
Fig. 4.5	Reduction of air content in mortar during hardening.....	50
Fig. 4.6	Bubbles size distribution of mortar specimens using SP1.....	51
Fig. 4.7	Bubbles size distribution of mortar specimens using SP2.....	52
Fig. 4.8	Bubbles size distribution of mix proportions mixed by water dividing mixing method.....	53
Fig. 4.9	Example photos of air bubbles in mortar specimens.....	54
Fig. 4.10	Number of bubbles in mortar with different size, considered the same air content.....	55
Fig. 4.11	Rate of reduction in R_{mb} representing flowability of mortar.....	56
Fig. 4.12	Low rate of reduction in R_{mb} due to the presence of entrained air with water dividing mixing method in mortar using conventional superplasticizer.....	56
Fig. 4.13	Low rate of reduction in R_{mb} due to high total surface area of entrained bubbles.....	57
Fig. 4.14	Mitigation in $(1-R_{mb}/R_m)$ due to the presence of entrained air.....	58
Fig. 4.15	Degree of $(1-R_{mb}/R_m)$ due to total surface area of bubbles.....	58
Fig. 4.16	Significant difference of air content measured by weight and LTM of mortar with AE dosage of 0.2%.....	59
Fig. 4.17	Effect of mixing method and the presence of entrained air on R_m and R_{mb}	60
Fig. 4.18	The reduction in funnel speed due to the presence of entrained air.....	61
Fig. 4.19	Total surface of bubbles of each diameter size.....	62
Fig. 4.20	Percentage of shared surface of bubbles in mortar.....	62
Fig. 4.21	Large total surface area of bubbles due to water dividing mixing method.....	63

Fig. 4.22	Combination of mortar effect and effect of entrained air on the increase of R_{mb} and R_m	63
Fig. 4.23	Large bubbles is compressed by aggregate.....	64
Fig. 4.24	Small bubbles is compressed by aggregate.....	65
Fig. 4.25	Bubbles size distribution of entrained air using AE dosage of 0.005%.....	65
Fig. 4.26	Bubbles size distribution of entrained air using AE dosage of 0.15%.....	66
Fig. 4.27	Bubbles size distribution of entrained air by water dividing mixing method...67	
Fig. 4.28	Total surface area of bubbles of each diameter size in concrete.....	67
Fig. 4.29	Percentage of shared surface of bubbles in concrete.....	68
Fig. 4.30	Total surface of bubbles in concrete.....	69
Fig. 4.31	Total surface area significantly related to self-compactability of concrete.....	69

CHAPTER 1

INTRODUCTION

1.1 Necessity for reduction in unit cost of self-compacting concrete

Self-compacting concrete (SCC) was developed over 25 years ago in order to improve durability of concrete structures. This concrete is well-known as high performance concrete that can flow into the corners of formwork by its own weight without any vibration. However SCC has not been extensively used in many countries due to its high unit cost. Cement content in mix proportion of SCC is approximately 2 times higher than that of normal concrete, and aggregate content is limited as lower than that of normal concrete, as shown in **Fig. 1.1**. Therefore SCC has not been extensively used. This type of concrete has been frequently used in special RC structures such as special foundation that contains massive volume of reinforcement bars, or prestressed concrete structures that the compactness of concrete have to be ensured.

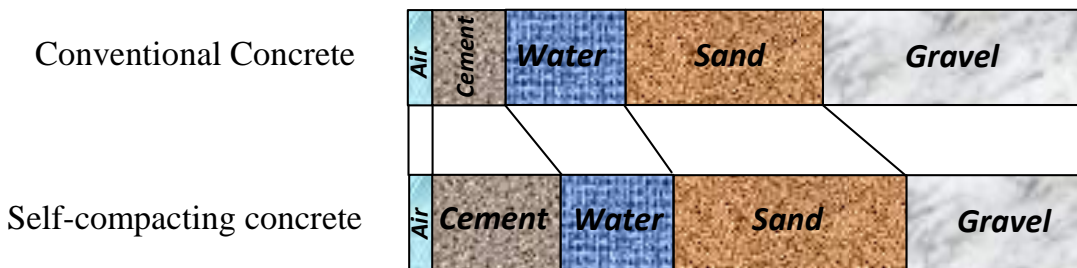

Fig. 1.1 Mix proportion of Self-compacting concrete and conventional concrete [1]

According to “JSCE Recommendation for Self-Compacting Concrete” [2]. Water to cement ratio (W/C) is recommended to be in range of 28-33% by weight in order to ensure that segregation will not be occurred. And sand to mortar ratio (s/m) is also limited approximately as 45% by volume. Flowability and self-compactability of SCC is very sensitive to unit volume of coarse aggregate in mix proportion. Accordingly, volume of coarse aggregate is recommended as approximately in range of 30-33%. According to the limitation of materials amount used for SCC mentioned previously, high amount of cement is necessary to achieve SCC with sufficient self-compactability.

Generally, unit cost of cement is highest among materials used for concrete. Therefore the method for reducing unit cost of SCC is the reduction in cement content and the increase in aggregate content. The increase in aggregate content apparently affects flowability and self-compactability which is the most important property of SCC. Consequently, flowability and self-compactability have to be improved first, and then aggregate content will be able to increase results in automatic reduction in cement content.

In Japan, SCC has not been extensively used in general construction project due to its high unit cost, it has been frequently used in special concrete structures such as anchorage structure of Akashi Kaikyo bridge. Although labor cost can be reduced, but the cost of concrete work is still high in overall. Researchers attempted to reduce unit cost of SCC by reducing cement content because cement is the most expensive materials among ingredients of concrete. Unfortunately, cement content has to be maintained as high amount in order to react to superplasticizer for producing pushing forces between cement particles. Recently, new type of superplasticizer was developed by blending with viscosity modifying agent. Using new type of superplasticizer, W/C could be increased up to 45% without segregation. However, fine aggregate content (s/m) could not be increased over 45% Cement content was slightly reduced and aggregate content could not be increased, thus unit cost of SCC could not be significantly reduced.

The limitation of sand to mortar ratio is shown in **Fig. 1.2**. The degree of friction in mortar is represented as degree of interaction between model coarse aggregate and mortar ($I-R_{mb}/R_m$) obtained from mortar experiment. Evaluation method for this index is explained in next subchapter. ($I-R_{mb}/R_m$) of mortar with s/m of 40% and 45% were lower than 0.4 which represented desirable flowability of mortar for SCC. In spite of the different s/m of mortar, ($I-R_{mb}/R_m$) was slightly different because amount of solid particles was very low. Therefore the increase in friction due to the collision of sand particles during deformation was not significant. The increase in s/m of over 45% resulted in significantly increased in ($I-R_{mb}/R_m$). This index increased from 0.371 to 0.485 and 0.590 by increasing s/m from 45% to 50% and 55% respectively. It increased approximately 0.1 by increasing s/m of 5%.

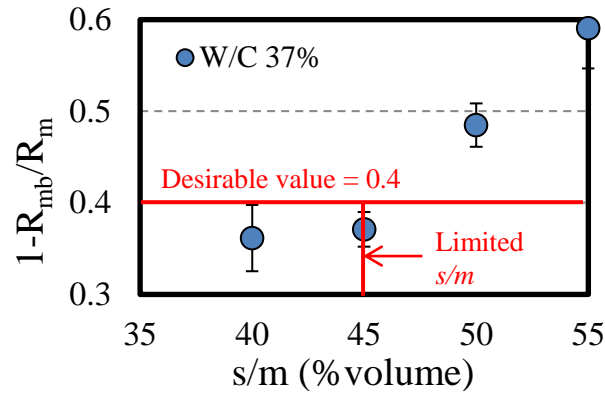

Fig. 1.2 Internal friction increased due to the increase in sand particles

This meant that flowability of mortar greatly decreased due to the increase in s/m of over 45% which could not be achieved self-compacting concrete by mixing with real coarse aggregate. Accordingly, designed s/m of 45% has been used as the upper limit of fine aggregate content for SCC.

1.2 Trial for reduction in unit cost with the increase in W/C and using viscosity agent

Various factors on degree of friction in mortar such as amount of solid particles, water amount and viscosity agent have been studied in order to increase flowability by reducing friction in mortar matrix. Degree of friction significantly related to those factors which directly affected flowability of mortar. The experimental results are presented as follow.

1.2.1 Purpose of reduction in friction

Flow behavior of SCC during deformation is considered in the term of shear resistance, as shown in **Fig. 1.3** [3]. Mortar's shear resistance increases due to the increase of normal stress by the approaching of coarse aggregate. Degree of shear resistance depends on sand content in mortar that it will be high due to high amount of sand to mortar ratio (s/m) resulting in the limitation of s/m for SCC which is approximately of 45% by volume. This is the reason that s/m could not be increased more than 45%. Accordingly, in order to increase flowability and self-compactability of SCC, internal friction has to be reduced.

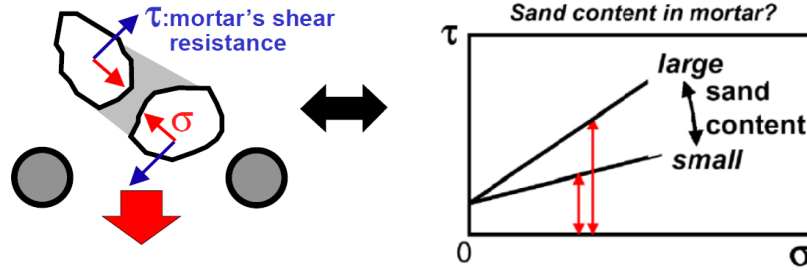

Fig. 1.3 Shear resistance of mortar (τ) in accordance with normal stress (σ) [3]

1.2.2 Convenience of mortar experiment

Since self-compacting concrete was developed over the past 25 years, testing method for evaluating rheological properties of SCC was also created. Self-compactability of SCC is measured in order to ensure that SCC can fully flow into all area in formwork and it can be fully compacted by its own weight. The apparatus used for measuring self-compactability is Box test as shown in **Fig. 1.4**. Suitable SCC is concrete that flows through the obstacle in box test and finally reaches the filling height of 250mm-300mm.

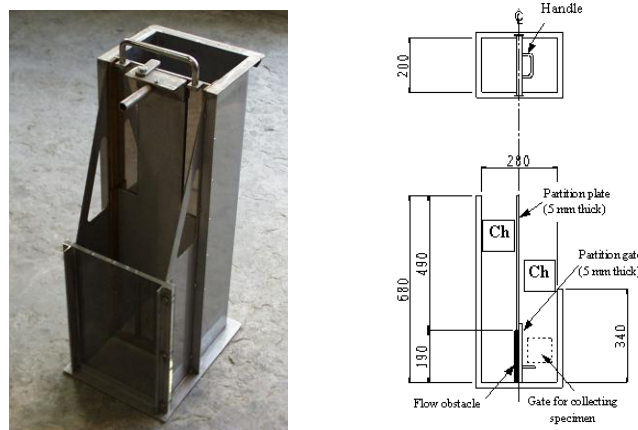

Fig. 1.4 Standard box test for SCC

Moreover box test can be used for initially examining the segregation between coarse aggregate and mortar. In case of segregation occurs, coarse aggregate settle into bottom of apparatus resulting in the flowing blockage of SCC. Therefore concrete cannot reach the optimum value of filling height. In addition to the test of fresh SCC, standard V-funnel and standard cone are employed in order to measure deformability and viscosity of concrete mix. In general of conventional self-compacting concrete with excellent self-compactability, the

time that concrete flow through standard V-funnel is approximately 10 second and diameter of flow area by using standard cone is approximately 650mm [1]. These values have been using as target value for suitable SCC. However these values might be different for SCC with different materials or different mix proportion. Accordingly, deformability and viscosity of all mix proportions need to be measured for evaluating degree of self-compactability of SCC.

1.2.3 Evaluation method for degree of friction in mortar

To avoid laborious work by mixing various mixes of concrete, mortar experiment was firstly performed. Factors considered in this study were applied to mortar experiment at the beginning in order to initially evaluate flowability of mortar. Once there are significant results are observed, mortar mix proportions will be mixed with real coarse aggregate in order to measure self-compactability and flowability of concrete and to check practicability of mix proportions.

Mortar experiment was conducted in a controlled room in which the temperature and relative humidity were constant at 20°C and 95% respectively. Every mix proportion was mixed by the same process, which was very punctual to the time in each step. Firstly, cement and sand were firstly mixed together for 30 seconds, and then liquid materials (water and superplasticizer) were added and mixed for 120 seconds as shown in **Fig. 1.5**.

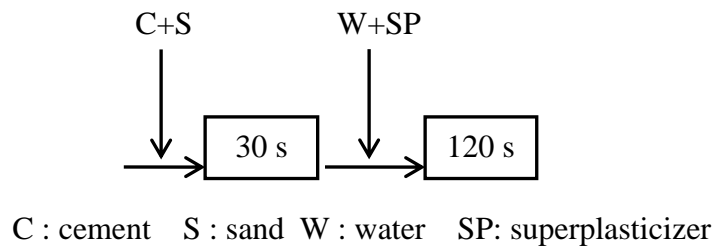

Fig. 1.5 Mixing procedure of mortar experiment

Deformability of mortar was measured at 5th minutes in order to measure initial deformability. Deformability of mortar (G_m) was calculated in accordance with **Fig. 1.6**. Subsequently, flowability test by funnel test was performed, as shown in **Fig. 1.7**. Deformability test was performed again at 20th minutes in order to measure deformability at working condition. Mortar have to be satisfied the proper mortar that G_m is in range of 5.5 to 6.5 (cone flow is in

range 255 to 275mm), otherwise mix proportion will be adjusted and mix from the beginning until it satisfies the cone flow range.

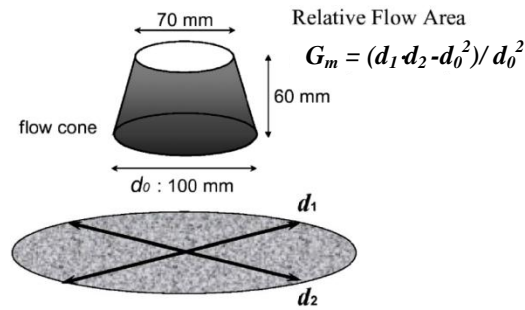

Fig. 1.6 Mortar flow test [4]

Once the proper mortar was achieved, flowability test of mortar was immediately performed after deformability test. Flowability of mortar (R_{mb}) was calculated in accordance with equation (1), then glass beads was added 20% of total volume of mortar and stirred for 20 times. Finally, flowability of mortar with model coarse aggregate (R_{mb}) was measured and calculated in accordance with equation (2). The proper mortar mixes were repeated 2 more times to confirm the stability of the results.

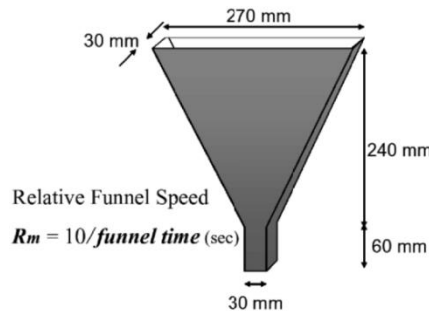

Fig. 1.7 Mortar funnel test [4]

$$R_m = 10/t_m \tag{1}$$

$$R_m = 10/t_{mb} \tag{2}$$

where,

t_m : funnel time of mortar (second)

t_{mb} : funnel time of mortar with model coarse aggregate (second)

The degree of interaction between model coarse aggregate and mortar is represented as $(1-R_{mb}/R_m)$ which is obtained from flowability of mortar (R_m) and mortar with model coarse aggregate (R_{mb}). It could be used as the preliminary index for evaluating the appropriate mortar for self-compacting concrete. According to previous study, degree of interaction between model coarse aggregate and mortar ($1-R_{mb}/R_m$) significantly related to the self-compactability of fresh concrete represented by filling height of concrete box test, as shown in Fig. 1.8 [5].

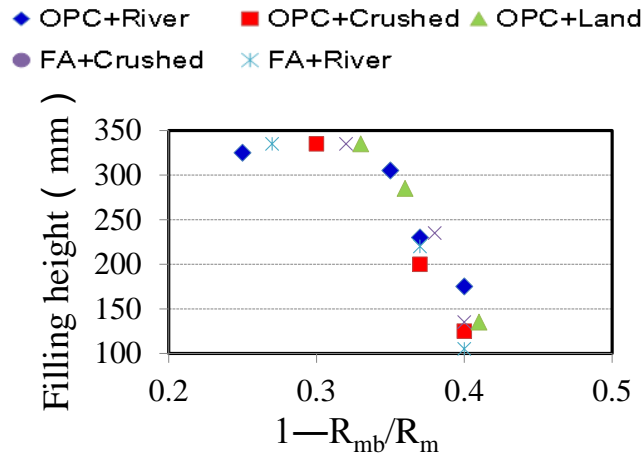

Where OPC : Ordinary portland cement River : River sand FA: Fly ash
 Crushed : Crushed limestone Land : Land sand

Fig. 1.8 The increase in filling height of concrete box test due to the reduction in $(1-R_{mb}/R_m)$ [4]

Although materials used for each mix proportion was different, the relationship between filling height and $(1-R_{mb}/R_m)$ is unique. Therefore the index of $(1-R_{mb}/R_m)$ is capable to be used to primarily evaluate self-compactability of fresh concrete. Filling height increased gradually due to the decrease of $(1-R_{mb}/R_m)$ from 0.4-0.32. When $(1-R_{mb}/R_m)$ reduced to be approximately 0.32, filling height reached the maximum value which is over 300mm. To achieve sufficient self-compactability for SCC that filling height should be higher than 250mm, it could be said that $(1-R_{mb}/R_m)$ should be approximately lower than 0.38.

1.2.4 Effect of water content on reduction in friction in mortar

As recommended by JSCE, segregation resistance of aggregate which is important property of concrete could be ensured by using water to cement ratio (W/C) in range of 28-37% by weight. This number was low comparing to W/C of normal concrete causing high unit cause of SCC. The increase in W/C automatically results in reduction cement content, however it is possible that segregation will be occurred due to high amount of free water in concrete matrix. Moreover ($I-R_{mb}/R_m$) might be capable to be mitigated due to the increase of free water. This series presents the limitation of water to cement ratio (W/C) and its effect on mitigation of degree of interaction between model coarse aggregate and mortar ($I-R_{mb}/R_m$). Materials used are listed in **Table 1.1**

Table 1.1 Materials used for series of studying effect of s/m

Cement	Fine aggregate	Superplasticizer	Model coarse aggregate
Ordinary portland cement (3.15 g/cm ³)	Crushed Limestone (2.7 g/cm ³ , F.M. 2.76)	Polycarboxylic base superplasticizer (SP1)	Glass beads (2.55 g/cm ³ , uniform diameter of 10 mm.)

To study the limitation of water to cement ratio for SCC, W/C were varied from the recommended amount of 30% to 50% which was over the recommended amount. It is expected that ($I-R_{mb}/R_m$) will be reduced due to the increase in W/C . Therefore sand to mortar ratio of 50% and 55% were tested with various amount of W/C . Parameters set up for this series are shown in **Table 1.2**.

Table 1.2 Parameters set up to study effect of W/C on $I-R_{mb}/R_m$

s/m (% by volume)	45					50			55			
W/C (% by weight)	30	32	35	37	40	35	40	45	35	40	45	50

Fig. 1.9 shows the mitigation in degree of interaction between model coarse aggregate and mortar ($I-R_{mb}/R_m$) affected by the increase of water content in mortar mix proportions. It can be seen that ($I-R_{mb}/R_m$) decreased gradually due to the increase in W/C in all 3 mixes with s/m of 45%, 50% and 55% because water behave like the lubricant of sand particles in mortar

matrix resulted in enhancement of flowability of fresh mortar. There was inverse result on this tendency that $(1-R_{mb}/R_m)$ increased due to the increase in W/C . $(1-R_{mb}/R_m)$ of mortar with s/m of 55% slightly increased by increasing W/C from 37-40%. This might be caused by dense volume of sand particles in which the W/C of 40% was not sufficient to reduce internal friction. In case of mix proportions with s/m of 45%, W/C was varied up to 40% which is slightly higher than the recommended amount. $(1-R_{mb}/R_m)$ decreased from 0.386 to 0.320 by increasing of W/C from 30%-40%. $(1-R_{mb}/R_m)$ of all mix proportions were lower than 0.4, it means that W/C for conventional self-compacting mortar could be increased up to 40% without segregation.

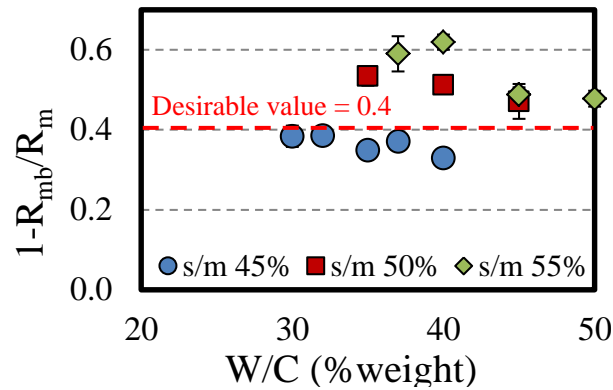

Fig. 1.9 Reduction in friction due to high amount of free water

In case of mix proportions with s/m of 50% and 55%, $(1-R_{mb}/R_m)$ was effectively mitigated by increasing of W/C . This index decreased to be 0.420 by using W/C of 40%-45% for mix with s/m of 50%. For mortar mixes with s/m of 55%, $(1-R_{mb}/R_m)$ decreased to be 0.478 by using W/C of 50%. In spite of effective mitigation in $(1-R_{mb}/R_m)$, water to cement ratio of 50% could not be applied because segregation of fine aggregate was observed in this mix. Thus suitable W/C for SCC was limited as 45%. Although $(1-R_{mb}/R_m)$ of mix with s/m of 50% could be reduced to be 0.420, this amount might not be sufficient for achieving self-compacting concrete. However the important point is that W/C of 45% can be used for self-compacting concrete. Although the increase of W/C from 30%-45% was not a great number, cement content needed for SCC was automatically reduced.

1.2.5 Effect of viscosity modifying agent on reduction in friction in mortar

Viscosity modifying agent (VMA) is generally used for preventing the variation of water amount occurred by the error of measurement ([Sakata]). VMA has been applied to superplasticizer production by blending it in manufacturing process in order to develop segregation resistance of SCC using this type of superplasticizer. The assumption is that there will be other effect on properties of fresh concrete. Flowability improvement is one of property expected to be observed in mortar mix proportions with VMA. Powder type of VMA was used in this series by mixing at the same time with cement and fine aggregate at the beginning of mixing process. In this series, mix proportions of convention self-compacting mortar were performed, thus sand to mortar ratio was kept constant as 45% and water to cement ratio was varied as 30%, 32%, 35% and 40%. Materials used in this series were the same as subchapter 1.8.2. Viscosity modifying agent used in this study was Welan gum which is produced by aerobic fermentation from corn syrup. Repeating of 4 types of sugars are the main chains of Welan gum as shown in **Fig. 1.10**. Parameters set up in this series are listed in **Table 1.3**.

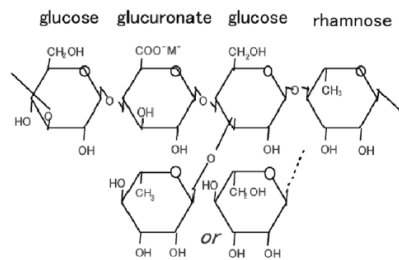

Fig. 1.10 Chemical structure of Welan gum [6]

Table 1.3 Parameters set up for series studying of effect of VMA

W/C 30%	W/C 32%	W/C 35%	W/C 40%
Dosage of VMA (% of cement weight)			
No VMA, 0.002, 0.004	No VMA, 0.002, 0.004, 0.006, 0.008, 0.010	No VMA, 0.002, 0.004, 0.006, 0.008, 0.010	No VMA, 0.002, 0.004

Results of effect of VMA on reduction in degree of interaction between model coarse aggregate and mortar $\Delta(I-R_{mb}/R_m)$ are shown in **Fig. 1.11**. $\Delta(I-R_{mb}/R_m)$ was calculated by

comparing between $(I-R_{mb}/R_m)$ of mortar with VMA and without VMA. Mix proportions with W/C of 30% and 40% were terminated at dosage of viscosity agent of 0.004% of cement weight because $\Delta(I-R_{mb}/R_m)$ tended to increase according to the presence of VMA. The $\Delta(I-R_{mb}/R_m)$ slightly increased due to the addition of viscosity agent. Conversely, $\Delta I-(R_{mb}/R_m)$ tended to decrease due to the presence of VMA in mortar with moderate W/C which were 32% and 35%. The optimum dosage of VMA for mitigating $(I-R_{mb}/R_m)$ of mixes with s/m of 32% and 35% were 0.004% and 0.002% respectively. The highest degree of reduction in $(I-R_{mb}/R_m)$ of those 2 mixes were 0.073 and 0.053 respectively.

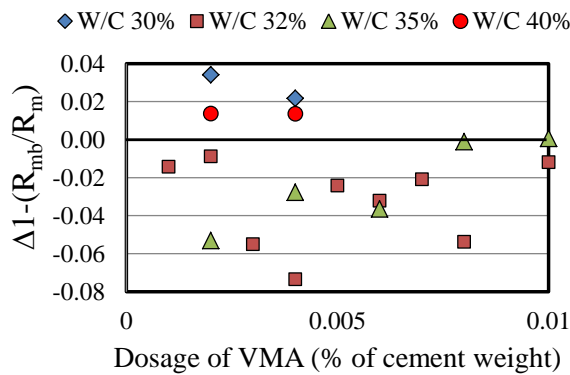

Fig. 1.11 Internal friction decreased in mortar with moderate W/C

However, there was no significant reduction in $(I-R_{mb}/R_m)$ for mix proportions added high amount of viscosity agent (0.01% of cement weight) comparing to mix proportion without viscosity agent. The increase in amount of viscosity agent reduced $\Delta(I-R_{mb}/R_m)$ to the optimum point, which was 0.073 and 0.053 of mortar with W/C of 32% and 35% respectively. After reaching optimum point, it can be apparently seen that $\Delta(I-R_{mb}/R_m)$ tended to increased according to the increase in dosage of viscosity agent. According to the results, flowability of fresh mortar could be increased by adding optimum dosage of viscosity agent in mix proportion. Unfortunately, it was effective only in mortar with moderate W/C (32%-35%), it was not effective for mortar with high and low W/C (30% and 40%). Accordingly, powder type of VMA could not be employed to support self-compacting concrete with low cement content because of moderate amount of W/C . It could be only used to increase flowability of conventional self-compacting concrete.

1.3 Purpose of this research

The purpose of this study is to improve self-compactability of fresh concrete by means of entrained air as factor reducing internal friction in concrete. In case of normal concrete, slump which is representing workability of concrete was slightly increased by adding entrained air approximately of 5%. Effect of entrained air on self-compactability of SCC has not been interesting research topic due to the disadvantage that is the reduction in compressive strength which is the main property of concrete. According to the increase in workability of normal concrete by adding entrained air, effect of entrained air on self-compactability of SCC is studied. This research investigates the improvement of flowability and self-compactability of self-compacting mortar and concrete by employing entrained air including effective procedure to improve quality of entrained air. Effective method includes suitable combination of materials used, effective mixing method and optimum amount of chemical admixtures in accordance with target mix design of SCC with low cement content. Characteristics of entrained bubbles at hardened stage are also performed by Linear Traverse Method (LTM) in order to deeply understand effective diameter size of entrained air on ball bearing effect. All of result and obtained data lead to the invention of alternative self-compacting concrete with low cement content called Air-enhanced SCC (AirSCC).

Air-Enhanced SCC (AirSCC) is created based on the concept that flowability and self-compactability of fresh concrete can be improved by adding entrained air in mix proportion. By these improvements, aggregate content especially fine aggregate content can be increased, resulted in reduction cement content and unit cost of SCC respectively. The purpose and concept of AirSCC are summarized in **Fig. 1.12**.

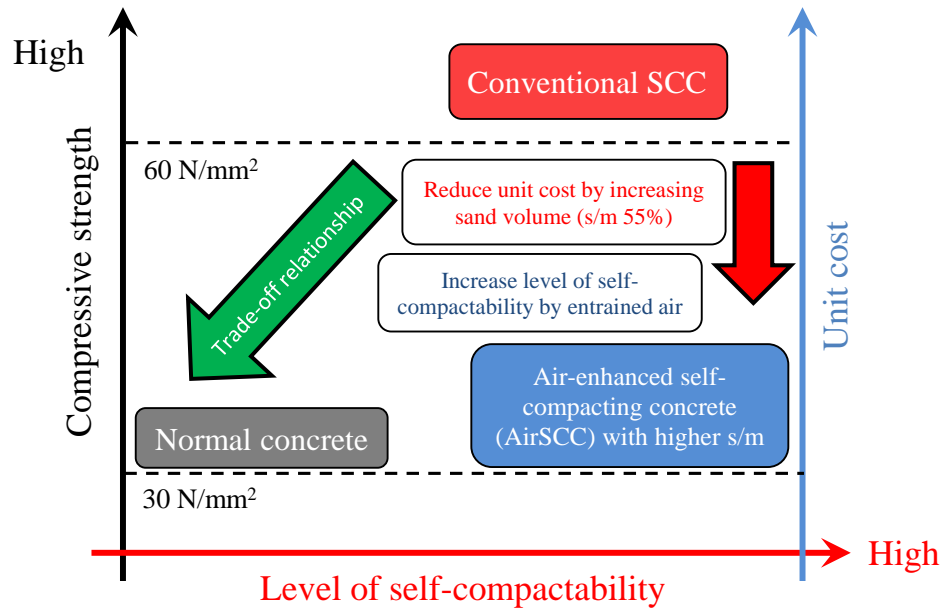

Fig. 1.12 Concept of the development of airSCC

Air content (entrained air and entrapped air) for improvement of rheological properties at fresh stage is initially set up as 10%. Compressive strength of concrete reduces approximately 50% by adding entrained air approximately of 10%. Despite the fact that compressive strength of SCC will be reduced 50%, it's still high, compared to compressive strength of normal concrete because the original compressive strength of SCC is very high. Accordingly, compressive strength of AirSCC is sufficient for general construction works. Fine aggregate content of SCC is considered in term of sand to mortar ratio (s/m) which represents unit volume of sand per volume of mortar. Sand to mortar ratio (s/m) of conventional SCC is recommended as approximately of 45% in order to ensure flowability of SCC [2]. To achieve AirSCC with low unit cement content, s/m is expected to be increased up to 55%, which results in effective reduction in cement content in mix proportion. Coarse aggregate content is maintained as the same as that of conventional SCC which is approximately of 30% by volume. Recently, water to cement ratio of SCC can be increased up to 45% without segregation by employing new type of superplasticizer which is blended with viscosity agent from production process. Accordingly the target mix proportion of AirSCC is proposed as shown in **Fig. 1.13**.

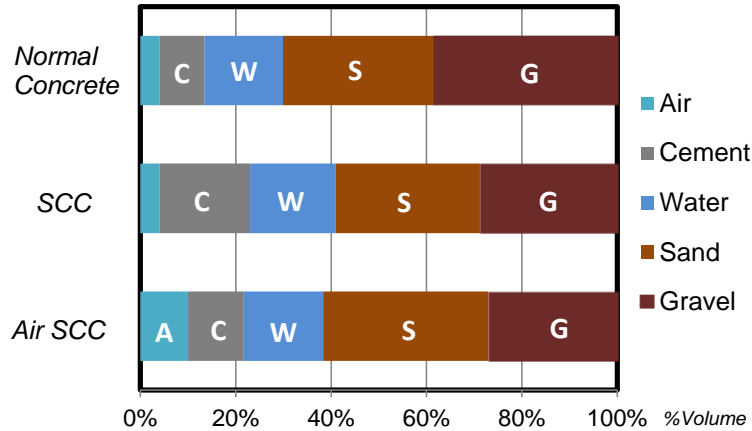

Fig. 1.13 Unit volume of materials in normal concrete, SCC and AirSCC

1.3.1 Enhancement of self-compactability with entrained air

The major advantage of entrained air for concrete is well-known as factor that it is added to concrete in order to increase freezing and thawing resistance of concrete in cold environment. The sufficient air content to resist freezing and thawing effect depends on severity of cold condition which is recommended as in range of 4.5-6.0% [2]. Moreover the minor advantage of entrained air for normal concrete has been reported which is workability improvement. Slump of fresh concrete increased approximately 10 to 50 mm by increasing entrained air approximately of 5% [3]. However the research works related to flowability enhancement of SCC by entrained air have not much been found.

Flowability of mortar is represented as the degree of interaction between model coarse aggregate and mortar ($1-R_{mb}/R_m$). According to research work in 2014, flowability of self-compacting mortar (SCM) was effectively improved by adding specific type of air entraining agent. **Fig. 1.14** shows the reduction in friction in mortar by means of different type of air entraining agent [6].

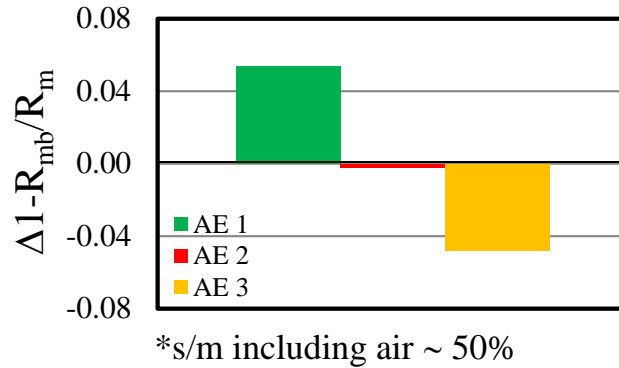

Fig. 1.14 Internal friction apparently decreased in mortar with AE 3

$(1-R_{mb}/R_m)$ apparently decreased by adding entrained air approximately of 8% produced by air entraining agent AE3. This means that ball bearing by entrained air was existed and effective. However the reduction in flowability has been found although air content was similar to other mixes. Unfortunately, the stability of entrained air was very low. Air content decreased approximately 50% within 2 hrs which was the main problem for this research. Accordingly, the authors attempted to improve flowability of SCM and SCC by adding entrained air and improve stability of entrained air simultaneously.

1.3.2 Ball bearing effect by entrained air in mortar

The mechanism that entrained air enhances flowability of mortar and concrete is Ball bearing effect [4]. Entrained air appears in mortar matrix as shown in **Fig. 1.15 a)**. Effective entrained air produced by specific type air entraining agent enhances flowability by trundling sand particles in mortar matrix as shown in **Fig. 1.15 b)**. According to previous research, problem of effective entrained air is stability itself. It's necessary to improve both ball bearing effect and stability of air simultaneously. The important point is that what are the fundamental properties of effective entrained bubble for improvement of ball bearing effect. Consequently basic characteristics of entrained bubbles will be measured. Moreover the method to increase stability of air is also presented.

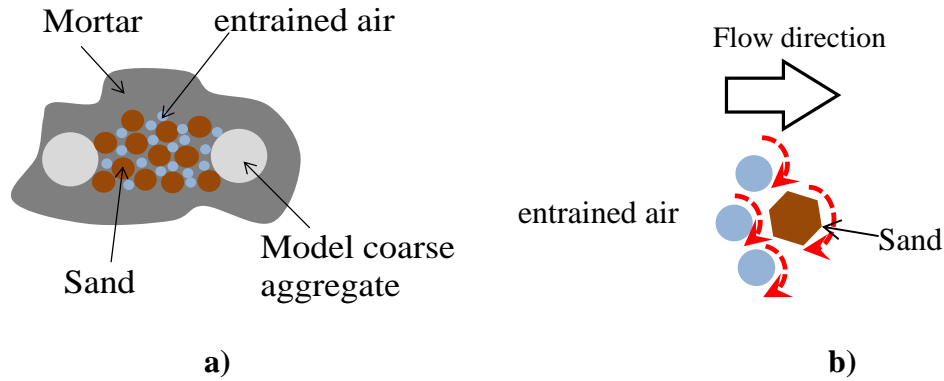

Fig. 1.15 Ball bearing effect by entrained air in mortar [4]

1.4 Outline of research

This study is divided into 2 main parts: Investigations for enhancement of self-compactability in **Chapters 1, 2 and 3** and verification of the mechanism in **Chapter 4**.

Chapter 1 describes overview, problems, objectives of current research. Furthermore, the current situation of application of self-compacting concrete and the necessity of self-compacting concrete with low cement content was described. Air-enhanced SCC (AirSCC) is created as SCC with low unit cement content and self-compactability enhancement by entrained air. Cement content of AirSCC was apparently reduced. Moreover, the target mix proportion of AirSCC is also proposed. This chapter also describes the importance of mortar experiment on concrete experiment. Testing procedure of mortar and concrete experiment is clearly explained. Relationship between results of mortar and concrete experiment are shown in function of flowability of fresh mortar and self-compactability of fresh concrete. Flowability of mortar is represented as the degree of interaction between model coarse aggregate and mortar ($I-R_{mb}/R_m$) which is obtained from standard apparatus for mortar experiment. This index can be used to initially evaluate self-compactability of fresh concrete.

Chapter 2 shows results of flowability of mortar and self-compactability of concrete affected by the presence of entrained air. Internal friction of mortar significantly decreased due to the presence of entrained air produced by individual type of air entraining agent. This resulted in the increase in flowability of mortar.

Chapter 3 shows the improvement of flowability by entrained air of mortar with effective

mixing method. Additionally, mix proportion of mortar was verified with concrete experiment. Self-compactability of SCC was improved by entrained air produced by effective mixing method as well. Finally, mix proportion of the prototype of AirSCC with suitable entrained air content, low cement content and sufficient self-compactability is proposed.

Chapter 4 presents effective diameter size of entrained bubbles on reduction in friction in fresh mortar and concrete at hardened stage by performing Linear Traverse Method (LTM) according to ASTM C457. Bubbles size distribution is considered as significant factor on both flowability of mortar and self-compactability of concrete. Moreover, total surface of entrained bubbles was calculated and considered as an important factor on the improvement of self-compactability. In addition, the degree of increase in friction due to entrained bubbles in terms of total surface area could be estimated. Finally, degree of ball bearing effect can be estimated by using equation obtained from experimental results

The last **Chapter 5** concludes all contents in this research.

The structure of this research is shown in **Fig. 1.16**.

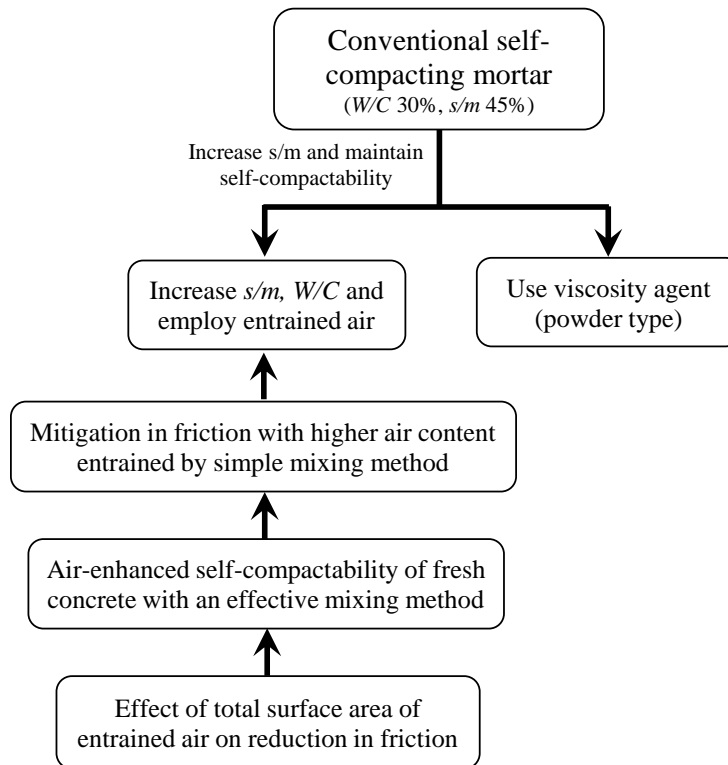

Fig. 1.16 Structure of research

CHAPTER 2

MITIGATION IN FRICTION WITH HIGHER AIR CONTENT ENTRAINED BY SIMPLE MIXING METHOD

2.1 Introduction

The purpose of this chapter is to clarify effect of higher air content on ball bearing effect of fresh concrete. Air entraining agent was added in order to produce entrained air which is expected to be an influence factor on reduction of friction in fresh mortar. The mechanism that entrained air mitigates internal friction is ball bearing effect as described in 1.3.2. The details of experiment and experimental results are written as follow.

2.2 Mitigation of friction in mortar by entrained air

Air entraining agent is liquid material, thus it is added to mix proportion concurrently with water and superplasticizer. Cementitious materials and fine aggregate are the same as materials in previous subchapter. In fact, toughness of bubbles increases due to the increase in viscosity of mortar. Therefore new type of superplasticizer (SP2) which is superplasticizer blended with viscosity agent was introduced for increasing viscosity of mortar. However conventional type of superplasticizer (SP1) was still being used as comparative factor in this series. Furthermore, 3 types of air entraining agent which are different in substrate were used in order to observe the compatibility of type of superplasticizer and air entraining agent on ball bearing effect. Materials used are listed in Table 2.1.

Table 2.1 Materials used for series of studying effect of entrained air on $1-R_{mb}/R_m$

Material	Details
Cement	Ordinary portland cement (3.15 g/cm ³)
Fine aggregate	Crushed limestone sand (2.68 g/cm ³ , F.M. 2.72)
Model coarse aggregate	Glass beads (2.55 g/cm ³ , uniform diameter of 10 mm.)
SP1	Conventional type of superplasticizer (1.044 g/cm ³)
SP2	New type of superplasticizer (1.044 g/cm ³)
AE 1	Alkyl ether-based anionic surfactants
AE 2	Modified rosin acid compound-based anionic surfactants
AE 3	High-alkyl carboxylic acid-based anionic surfactants

In addition to the study of ball bearing effect by entrained air, total volume of mortar increases according to the increase in air content. Therefore volume of mortar will be recalculated before adding glass beads in order to correctly put the exact volume of glass beads which is 20% of total volume otherwise the different in volume of model coarse aggregate will affect the result on $(1-R_{mb}/R_m)$. The calculation of exact volume of glass beads is shown in **Fig. 2.1**.

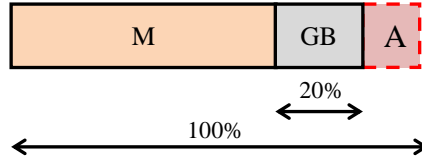

where M : volume of mortar GB : volume of glass beads A : volume of air

Fig. 2.1 Adjustment of volume of glass beads in accordance with volume of air

To clearly compare ball bearing effect by entrained air, sand to mortar ratio (s/m including air) was kept to be similar to each others. The target s/m including air was 45% and 49%. In fact, s/m including air could not be exactly the same as target amount because air content was very sensitive to mix proportion, it could not be fixed as certain number. However it was slightly different from the target amount. Mix proportions for study of ball bearing effect by entrained air are listed in **Table 2.2**. Air content varied in range of 7-13% due to type of air entraining agent. Accordingly original s/m (s/m excluding air) has to be varied in order to obtain target s/m including air.

Table 2.2. Target mix proportions for studying ball bearing effect by entrained air

Parameter	Value
Original s/m	Varied from 50%-56% by volume, depend on target s/m
W/C	45% by weight
Model coarse aggregate	20% of total volume including air content
SP1	Varied, depend on s/m and air entraining agent dosage
SP2	Varied, depend on s/m and air entraining agent dosage
AE 1	Varied in dosage and produced entrained air approximately 7-13% (including entrapped air)
AE 2	Same as above
AE 3	Same as above

Table 2.3 and **Table 2.4** show the list of mix proportions using convention type and new type of superplasticizer respectively. It can be seen that air content could not be produced over 8% by using AE3, thus the original s/m was lower than mix proportions with the other types of superplasticizer. Mortar mixes without entrained air were set up as control mixes in which no ball bearing effect by entrained air.

Table 2.3 Mix proportions using convention type of superplasticizer

Original s/m	Type of AE	s/m (including volume of air) (%)	Volume of air (%)
50	No AE	48.9	2.3
55	AE 1	48.7	13.0
55	AE 2	49.1	12.0
53	AE 3	49.1	8.0
45	No AE	44.1	1.9
50	AE 1	45.5	10.0
50	AE 2	44.5	12.3
48	AE 3	44.7	7.3

Table 2.4 Mix proportions using new type of superplasticizer

Original s/m	Type of AE	s/m (including volume of air) (%)	Volume of air (%)
50	No AE	48.7	2.7
56	AE 1	50.1	11.7
55	AE 2	49.5	11.2
53	AE 3	49.1	8.0
47	No AE	46.4	1.4
50	AE 1	45.5	10.0
50	AE 2	45.6	9.5
49	AE 3	45.9	6.7

Fig. 2.2 shows the degree of mitigation of $(1-R_{mb}/R_m)$ by ball bearing effect of mortar using conventional type of superplasticizer. There were 2 groups of result: group of s/m including air of approximately 45% and 49%. It can be seen in **Fig. 2.2 a)** that the first group that the degree of interaction between model coarse aggregate and mortar $(1-R_{mb}/R_m)$ slightly decreased from approximately 0.4 (mix without AE) due to the presence of entrained air

produced by 3 types of AE. This was an advantage on flowability improvement. On the other hand, significant results on $(1-R_{mb}/R_m)$ have been observed in the second group, ball bearing effect was effective for mitigating $(1-R_{mb}/R_m)$ by means of AE3. $(1-R_{mb}/R_m)$ decreased from 0.426 to 0.378 due to entrained air content of 8% produced by AE3. Conversely, $(1-R_{mb}/R_m)$ increased from 0.426 to 0.480 due to 13.0% of entrained air content produced by AE1. And no significant reduction in $(1-R_{mb}/R_m)$ has been observed in mix proportion using AE2. $(1-R_{mb}/R_m)$ of mix with AE2 was almost the same as that of mix without AE, which was approximately 0.425. In case of mortar using convention type of superplasticizer, it can be said that ball bearing effect by entrained air was effective for increasing flowability of fresh mortar. However, it was effective only in which mortar using specific type air entraining agent (AE3).

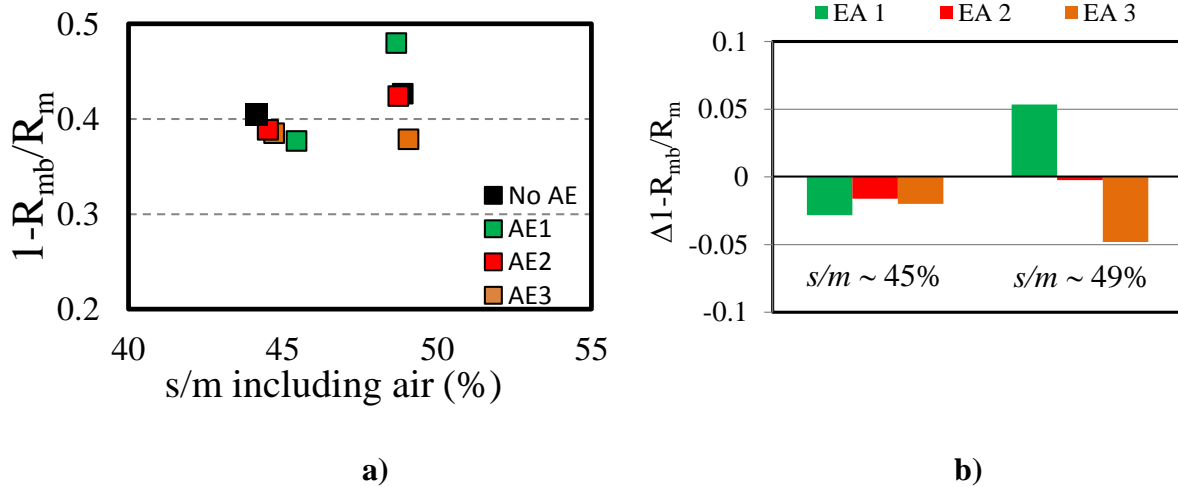

Fig. 2.2 Degree of mitigation in friction by ball bearing effect of mortar using conventional type of superplasticizer

a) Degree of friction in mortar b) Degree of mitigation in friction

Fig. 2.2 b) shows the degree of mitigation of interaction between model coarse aggregate and mortar $\Delta(1-R_{mb}/R_m)$ by using AE 1, AE 2 and AE 3 with superplasticizer SP1, comparing with mortar without entrained air. In case of s/m of approximately 45%, the degree of mitigation of $(1-R_{mb}/R_m)$ by ball bearing effect was observed. Entrained air produced by 3 types of AE enhanced ball bearing effect. The degree of mitigation was approximately 0.02, this value was small for increasing flowability of mortar. In case of s/m of approximately 49%, the degree of mitigation was approximately 0.05 with AE 3. Conversely, negative effect on ball bearing

effect was found in mix using AE 1. And no significant results by using AE 2 have been found.

Basically, the degree of interaction between coarse aggregate and mortar ($1-R_{mb}/R_m$) is sensitive to amount of solid particles in mortar, it will increase due to the increase in fine aggregate content. However, it was different in case of mortar with AE3. ($1-R_{mb}/R_m$) was slightly decreased from 0.385 to 0.378 due to the increase of s/m including air from 44.7% to 49.1%. It can be concluded that ball bearing effect was existed by means of AE3. This was the desirable results of this study.

The degree of mitigation of ($1-R_{mb}/R_m$) by ball bearing effect of mortar using new type of superplasticizer is shown in **Fig. 2.3**. **Fig. 2.3 a)** shows the tendency of the results that was similar to that of mortar using conventional type of superplasticizer. In group of mortar with s/m including air was approximately 45%, the degree of interaction between model coarse aggregate and mortar ($1-R_{mb}/R_m$) slightly increased from 0.333 to 0.353 due to the presence of entrained air of 9.5% produced by AE2 comparing to ($1-R_{mb}/R_m$) of mortar without entrained air. And it increased to be 0.363 due to the presence of entrained air of 6.7% produced by AE3.

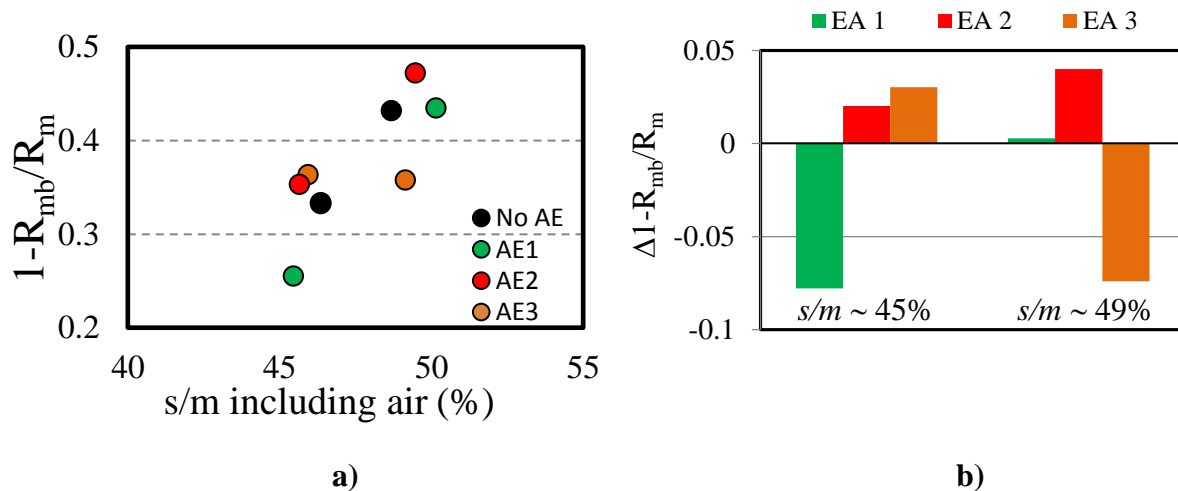

Fig. 2.3 Degree of mitigation in friction by ball bearing effect of mortar using new type of superplasticizer

a) Degree of friction in mortar b) Degree of mitigation in friction

This meant that AE2 and AE3 were not compatible with new type of superplasticizer for increasing flowability. The effective mitigation in ($1-R_{mb}/R_m$) was observed in mortar with

entrained of 10% produced by AE1. $(1-R_{mb}/R_m)$ decreased from 0.333 to 0.255 which was a desirable value for achieving SCC.

In group of mortar with s/m including air was approximately 49%, $(1-R_{mb}/R_m)$ of mortar without entrained air was 0.432. This index was effectively decreased to be 0.358 by adding 7.9% of entrained air produced by AE3. It can be said that air entraining agent type 3 (AE3) was compatible with new type of superplasticizer for improving flowability of self-compacting mortar. On the other hand, negative result on flowability of mortar occurred by mean of AE2. $(1-R_{mb}/R_m)$ increased to be 0.472 by adding entrained air of 11.2%. For mortar with AE1, $(1-R_{mb}/R_m)$ was 0.435 which was very close to that of mortar without entrained air. This means that entrained air produced by AE1 was not appropriate for ball bearing effect.

Fig. 2.3 b) shows the degree of mitigation of interaction between model coarse aggregate and mortar $\Delta(1-R_{mb}/R_m)$ by using those 3 types of AE with superplasticizer SP2 comparing to mortar without entrained air. In case of s/m of approximately 45%, $\Delta(1-R_{mb}/R_m)$ of mortar using AE 1 was 0.08, which was very high. AE 2 and AE 3 showed negative results on ball bearing effect. On the other hand, in case of s/m is approximately 49%, the degree of mitigation of $(1-R_{mb}/R_m)$ was approximately 0.08 by using AE 3. And negative results were observed in mortar using AE 1 and AE 2. It can be said that AE 3 effectively mitigated degree of friction in mortar with high s/m .

Effect of entrained air on reduction in friction in mortar was classified into 3 types, as shown in **Fig. 2.4**. Bar No.1 means positive effect on reduction in friction by entrained air, which could be explained that the characteristic of air bubbles were appropriate to resist shrinkage of bubbles and bubbles worked effectively as ball bearing simultaneously. Bar No.3 means negative result on reduction friction. This might be due to the shrinkage of bubbles, resulted in the increase in sand to mortar (s/m) and model coarse aggregate to mortar ratio consequently. Therefore, the friction in mortar was increased due to the increase in solid particles in matrix. Bar No.2 means no significant effect on reduction in friction in mortar. In this case, there are 2 possible assumptions that are entrained bubbles were not shrunk, but those bubbles did not work as ball bearing, or shrinkage partially occurred, but entrained bubbles were suitable for ball bearing effect.

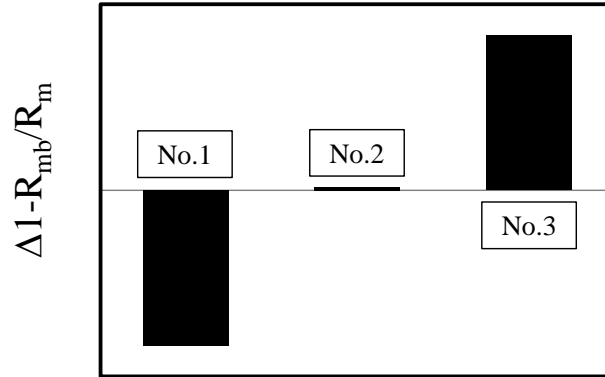

Fig. 2.4 The reduction in $I-R_{mb}/R_m$ by entrained air, comparing to mix without AE

2.3 Stability of entrained air in mortar

Unexpected defective result on reduction in air content was observed in mortar with air entraining agent type 3. Air content decreased approximately 50% in 30 minutes in both mortar with s/m including air of approximately 45% and 49%. At 5th minutes, air content was approximately 9-10%, and it became approximately 7-8% before testing mortar with glass beads at 20th minutes. Finally, air content decreased to be approximately 5% at 30th minutes. Air content directly affected flowability of mortar and it also affected self-compactability of concrete. Therefore to achieve self-compactability improvement by entrained air, stability of air has to be taken into account simultaneously.

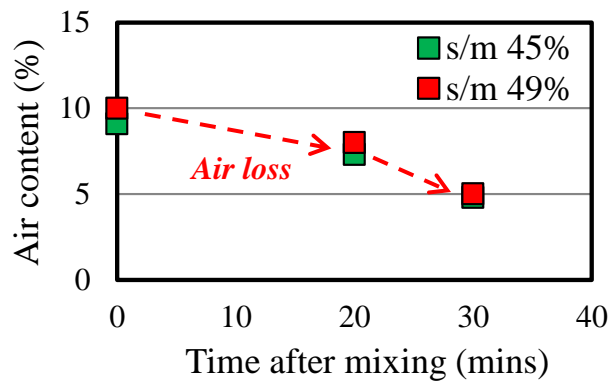

Fig. 2.5 Low stability of entrained air

2.4 Summary

It can be concluded that the mitigation of internal friction by ball bearing effect of entrained air was existed. However, it was effective only in mortar with a particular type of AE. The degree of interaction between model coarse aggregate and mortar ($1-R_{mb}/R_m$) representing degree of friction in mortar could be effectively mitigated by entrained air produced by air entraining agent type 3 (AE3) in mortar with high sand to mortar ratio (high s/m is the target of this research). High-alkyl carboxylic acid-based AE was compatible with both conventional type and new type of superplasticizer. However, the main disadvantage of using this combination was the stability of entrained air itself. The improvement of both self-compactability and stability of air is necessary. The method to improve those properties of fresh mortar and concrete is presented in **Chapter 3**.

CHAPTER 3

AIR-ENHANCED SELF-COMPACTABILITY OF FRESH CONCRETE WITH AN EFFECTIVE MIXING PROCEDURE

3.1 Introduction

The purpose of this chapter is to improve ball bearing effect and stability of entrained air itself simultaneously. According to the effect of entrained air on degree of interaction between model coarse aggregate and mortar ($I-R_{mb}/R_m$) in **Chapter 2**, ball bearing effect by entrained air produced by a particular type of air entraining agent was existed and effective.

However, air content severely decreased approximately 50% in 30 minutes. This is the main problem of Air-enhanced self-compacting concrete because self-compactability depended on exact fine aggregate content (s/m) which was directly affected by the variation of air content in cement paste.

In this chapter, new mixing method called “Water dividing mixing method” and “Last adding AE mixing method” were introduced based on the idea that quality of entrained air depends on condition of mortar portion before adding air entraining agent. Improvement of stability of entrained air and quality of entrained bubbles on mitigation in ($I-R_{mb}/R_m$) were observed. The explanation in details of those mixing method is presented in next subchapter. In addition to new mixing method, some mix proportions needed large amount of air entraining agent for producing target air content, and the difference in dosage of air entraining agent showed different results on mitigation in ($I-R_{mb}/R_m$) in spite of similar air content. Furthermore results of mortar experiment were verified with concrete experiment in order to confirm applicability for practical use.

3.2 Outline of water dividing mixing method with Last adding AE mixing method for mortar experiment

In order to make mortar portion soft before adding air entraining agent, air entraining agent was separately added from superplasticizer. In general, dosage of air entraining agent is very small for producing air content approximately 10%. It needs to be dissolved with water to

prevent the error during at step of pouring air entraining agent. Some of air entraining agent can be attached with container and make error on exact dosage. Accordingly, water was also halved and separately mixed with superplasticizer and air entraining agent as shown in **Fig. 3.1**. Firstly, cement and sand were mixed together for 30 seconds, and then 50% of water with superplasticizer were added and mixed for 60 seconds. At this step, authors attempted to make mortar soft before adding air entraining agent. This might affect characteristic of air bubbles in mortar. Then another 50% of water with air entraining agent were added and mixed for 60 seconds. Moreover, Last adding AE mixing method was also introduced because high dosage of air entraining agent was necessary for producing air content approximately 10% in some mix proportions. The error occurring during pouring will be small. Thus air entraining agent could be individually added to mix proportion as shown in **Fig. 3.2**. By this mixing method, mortar portion before adding air entraining agent was softer than that of water dividing mixing method.

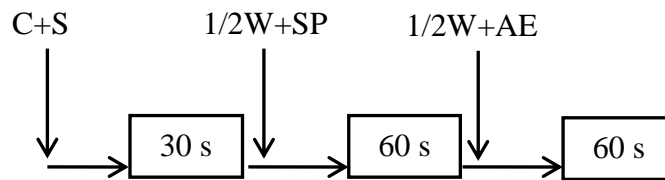

C : cement S : sand W : water G : Gravel SP : superplasticizer AE : air entraining agent

Fig. 3.1 Water dividing mixing method for mortar

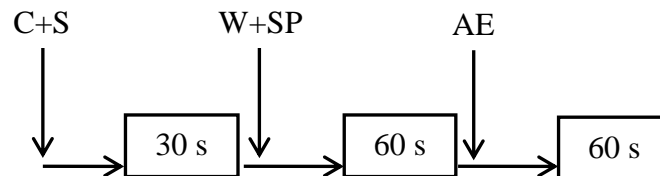

C : cement S : sand W : water G : Gravel SP : superplasticizer AE : air entraining agent

Fig. 3.2 Last adding AE mixing method for mortar

3.3 Materials used and parameters set up for mortar experiment

Materials used are similar to that of previous chapter except air entraining agent. Vinsol resin

is a type of air entraining agent attaining high viscosity. Coarse aggregate is used in concrete experiment for verifying results of mortar. Coarse aggregate volume was fixed as 30% of concrete volume for all concrete mixes which was the suitable amount for SCC. The proportion of coarse aggregate is the same for every concrete mixes. Coarse aggregate is classified into 2 classes which are coarse aggregate with size in range of 5-15mm and 15-20mm. Ratio between those size of coarse aggregate used is 6:4. Materials used are listed in **Table 3.1.**

Table 3.1 Materials in use for test on effect of mixing method in terms of $I-R_{mb}/R_m$

Material	Details
Cement	Ordinary portland cement (3.15 g/cm ³)
Fine aggregate	Crushed limestone sand (2.68 g/cm ³ , F.M. 2.72)
Model coarse aggregate	Glass beads (2.55 g/cm ³ , uniform diameter of 10 mm.)
Coarse aggregate	Limestone (2.7 g/cm ³ , F.M. 2.76) Size 5-15 mm 60%, Size 15-20 mm 40% Total coarse aggregate is 30% of volume of concrete
Conventional type of SP (SP1)	Superplasticizer without viscosity agent (1.044 g/cm ³)
New type of SP (SP2)	Superplasticizer blended with viscosity agent (1.044 g/cm ³)
Master Grenium 101 (AE1)	Alkyl ether-based anionic surfactants
Vinsol (AE4)	Anionic surfactant

Target air content in mortar was approximately 14% because it was aimed to be approximately 10% in concrete based on assumption that air content in cement paste of mortar and concrete are similar. As mentioned above, volume of coarse aggregate was constant as 30%, thus 14% of air content in mortar will be approximately 10% in concrete.

In order to clearly study effect of entrained air on the degree of interaction between model coarse aggregate and mortar ($I-R_{mb}/R_m$), sand to mortar (s/m) including air content is set approximately as 50%. Therefore designed s/m (s/m excluding air) was set as 57% for mix proportion with entrained air. In case of mix proportions without entrained air, entrapped air was assumed approximately as 2%, accordingly the designed s/m for mortar without entrained

air was set as 51%. Dosage of air entraining agent for achieving target air content was varied due to mixing method and type of chemical admixture added to each mix proportion. Mix proportions of mortar experiment are listed in **Table 3.2**.

Table 3.2 Mix proportions of mortar

Mixing method	W/C	s/m	SP	AE	AE dosage (% of cement)
Simple mixing. method	45%	51%	SP1	-	-
		57%		AE1	0.006
		57%	AE4	0.003	
		51%	SP2	-	-
		57%		AE1	0.004
		57%		AE4	0.004
Water dividing mixing. method		51%	SP1	-	-
		57%		AE1	0.011
		57%	AE4	0.008	
		51%	SP2	-	-
		57%		AE1	0.158
		57%		AE4	0.158
Last adding AE mixing. method	57%	SP2	AE1	0.158	

3.4 Dosage of air entraining agent needed due to different mixing method

Dosage of air entraining agent was trial and error until target air content was achieved. **Fig. 3.3** shows relationship between dosage of air entraining agent and initial air content in mortar with different mixing method.

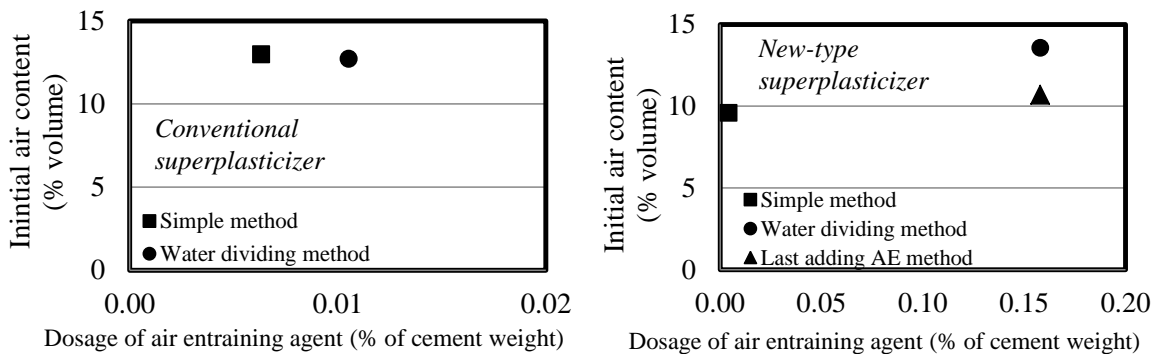

Fig. 3.3 Excessive dosage of AE is necessary for new method with new type of superplasticizer

Dosage of air entraining agent needed for achieving target air content was small as approximately of 0.003-0.006% of cement weight by simple mixing method in both cases of mix proportion using conventional and new-type superplasticizer. By water dividing mixing method and Last adding AE mixing method, sufficient dosage of air entraining agent differed from that of simple mixing method. It was approximately 0.010% by using conventional superplasticizer and 0.158% by using new-type superplasticizer.

It can be said that condition of mortar before adding air entraining agent was influence factor on the sufficient dosage of air entraining agent (AE). In mortar with conventional superplasticizer, soft mortar by water dividing mixing method needed dosage of air entraining agent higher than that of stiff mortar by simple mixing method which was approximately 2 times. Production rate of entrained air decreased in soft mortar because of the reduction in friction during mixing process especially in mix proportion using new-type superplasticizer. Dosage of air entraining agent became approximately 40 times by using new-type superplasticizer with water dividing and Last adding AE mixing method comparing to simple mixing method. This dosage was apparently different from dosage for mortar using conventional superplasticizer. Viscosity agent blended in superplasticizer might inhibit production of entrained air during mixing process, thus excessive dosage of AE was necessary for producing target air content.

3.5 Results of flowability of mortar by different mixing method

Fig. 3.4 shows relationship between flowability of mortar (R_m) and mortar with glass beads (R_{mb}) of mix proportions using conventional superplasticizer.

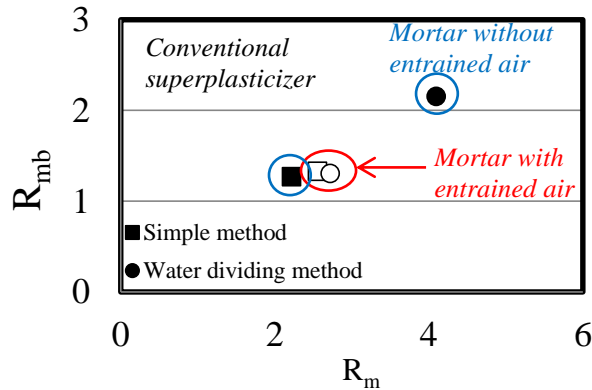

Fig. 3.4 Reduction of flowability due to the presence of entrained in mortar using conventional superplasticizer

Funnel speed of mix proportions mixed by water dividing mixing method were significantly higher than that of mix proportions mixed by simple mixing method, considering mix proportions without entrained. In case of mix proportion using simple mixing method, funnel speed slightly increased due to the presence of entrained air. On the other hand, in case of mixes using water dividing mixing method, funnel speed apparently decreased due to the presence of entrained air produced by both types of air entraining agent.

In fact, funnel speed of mortar directly relates to water retention by entrained air. Entrained air retains water in matrix resulted in reduction of funnel speed of mortar. The reduction in funnel speed by entrained air could be seen apparently in mortar mixed by water dividing mixing method. Entrained bubbles produced by AE4 made mortar more slightly viscous than that produced by AE1. Mortar with entrained air approximately of 9-13% used approximately 4-5 seconds.

Relationship between flowability of mortar (R_m) and mortar with glass beads (R_{mb}) of mix proportions using new-type superplasticizer is shown in **Fig. 3.5**. It can be apparently seen that funnel speed decreased due to the presence of entrained air in both mixing method. By using simple mixing method, R_m of mortar with entrained bubbles produced by AE1 and AE4 was not significantly different because air content was similar. On the contrary, R_m of mortar with entrained bubbles produced by AE4 was approximately 2 which was lower than R_m of mortar with AE1 which was approximately 3. Viscosity of mortar greatly increased by AE4 in spite of air content was slightly different because AE4 is viscous liquid material.

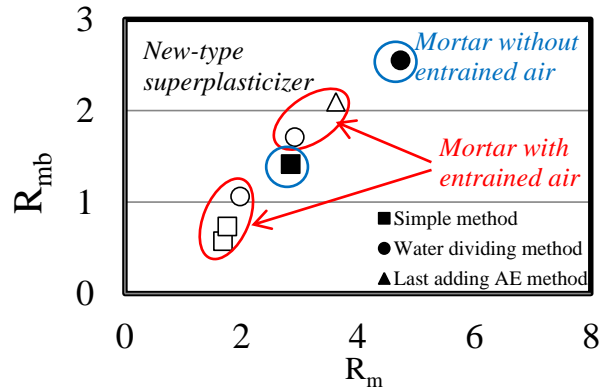

Fig. 3.5 Reduction of flowability due to the presence of entrained in mortar using new-type superplasticizer

Vinsol (AE4) is a kind of resin material. Moreover excessive dosage of air entraining agent was added to mortar mixed by water dividing mixing method that increased viscosity of mortar. Accordingly, viscosity of mortar with AE4 became very high due to the presence of entrained air and excessive dosage of AE4 resulted in low funnel speed (low R_m). R_m of mortar with AE1 was approximately 3 which was between R_m of mortar with AE4 and mortar without AE. Air entraining agent 101(AE1) is a kind of soapy material, thus viscosity of mortar was not high by excessive dosage of AE. The reduction in R_m was affected by the presence of entrained air.

3.6 Variation of degree of interaction between model coarse aggregate and mortar ($1-R_{mb}/R_m$) by entrained air with different mixing method

Effect of entrained air on degree of interaction between model coarse aggregate and mortar ($1-R_{mb}/R_m$) by different mixing method is presented. **Fig. 3.6** shows the result on $1-R_{mb}/R_m$ of mortar using conventional superplasticizer. Air content in mortar with entrained air and without entrained air is in range of 12-14% and 1.1-2.3% respectively. It can be seen that the ($1-R_{mb}/R_m$) increased approximately 0.05 due to the presence of entrained air produced by AE1. By using AE4, R_{mb} of mortar mixed by simple mixing method could not be tested. Mortar with glass could not flow through funnel, it was stopped during testing. In case of mortar mixed by water dividing mixing method, ($1-R_{mb}/R_m$) of mortar with entrained air and without entrained air was almost similar as approximately 0.48.

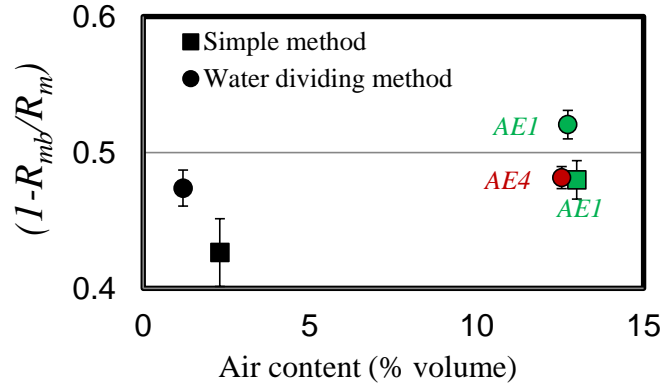

Fig. 3.6 The increase in $(1-R_{mb}/R_m)$ due to the presence of entrained air in mortar using conventional superplasticizer

By using conventional type of superplasticizer, the presence of entrained air of approximately 12-14% resulted in negative effect on mitigation in degree of interaction between model coarse aggregate and mortar ($1-R_{mb}/R_m$) in both mixing method. Effective entrained bubbles for improving self-compactability of self-compacting concrete could not be produced by conventional superplasticizer.

Significant result on mitigation of degree of interaction between model coarse aggregate and mortar was observed in mortar using new-type superplasticizer. The degree of ($1-R_{mb}/R_m$) of mortar using new type of superplasticizer is shown in **Fig. 3.7**. Air content in mortar with entrained air and without entrained air is in range of 9.6-14% and 1.1-1.9% respectively. Negative effect due to the presence of entrained on mitigation of ($1-R_{mb}/R_m$) was observed in mortar mixed by simple mixing method. ($1-R_{mb}/R_m$) increased approximately 0.16 and 0.08 by using AE1 and AE4 respectively. On the other hand, ($1-R_{mb}/R_m$) was mitigated by using water dividing mixing method with air entraining agent type AE1. ($1-R_{mb}/R_m$) of mortar decreased approximately 0.5 which was 0.413. Moreover ($1-R_{mb}/R_m$) of mortar mixed by Last adding AE mixing method slightly differed from that of mortar mixed by water dividing mixing method which was 0.421. However, air entraining agent type AE4 was not compatible with new-type superplasticizer for mitigating ($1-R_{mb}/R_m$). The index of ($1-R_{mb}/R_m$) of mortar with entrained air produced by AE4 was similar to that of mix without entrained are which was approximately 0.46.

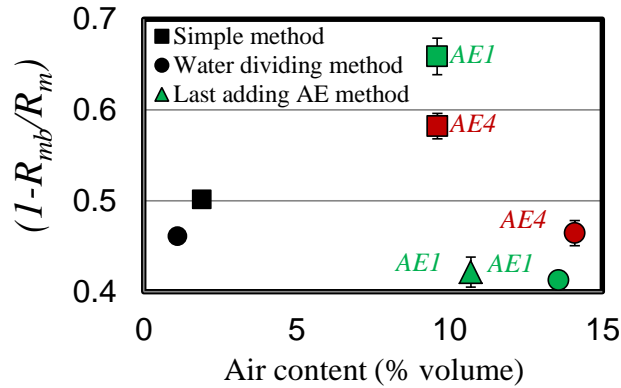

Fig. 3.7 The reduction in $(1-R_{mb}/R_m)$ due to the presence of entrained air in mortar using new-type superplasticizer

The interesting results from this series were that the mitigation in $(1-R_{mb}/R_m)$ only occurred in mortar with excessive dosage of AE1 and mixed by water dividing or Last adding AE mixing method. In spite of air content was approximately in range 9.6-14%, dosage of AE was apparently different depended on mixing method especially air entraining agent type AE1. Effective bubbles for self-compactability enhancement could be produced by water dividing mixing method with excessive dosage of specific type air entraining agent.

3.7 Effect of excessive dosage of air entraining agent on $(1-R_{mb}/R_m)$

This subchapter presents the effect of excessive dosage of air entraining agent on the mitigation of degree of interaction between model coarse aggregate and mortar $(1-R_{mb}/R_m)$. Normal and excessive dosage of AE were used for both mixing methods. New-type superplasticizer and air entraining agent type AE1 were selected in this series because it was the best combination for improving flowability of mortar. Finally, Water content and sand content were the same as in previous subchapter. Finally, the optimum dosage of AE will be proposed. Mix proportions of mortar are listed in **Table 3.3**.

Table 3.3 Mix proportions of mortar for studying effect of dosage of AE

Mixing method	W/C	s/m	SP	AE	AE dosage (% of cement)
Simple mixing method	45%	57%	SP2	AE1	0.004
					0.006
					0.150
Water dividing mixing method	45%	57%	SP2	AE1	0.005
					0.050
					0.100
					0.200

To achieve target air content of approximately 12-14%, dosage of air entraining agent was varied in accordance with mixing method. Small dosage of AE was sufficient for simple mixing method, whereas excessive dosage was necessary for water dividing mixing method as shown in **Fig. 3.8**. Excessive dosage of AE of 0.15% was added to mortar and mixed by simple mixing method. Air content in mortar was approximately 28% which was very high and it could not be applied for self-compacting concrete. Moreover, segregation of glass beads occurred due to excessive amount of air content. In case of mortar mixed by water dividing mixing method, target air content was achieved by adding dosage of AE of 0.05%. Saturated point of air content was observed at this point. Air content slightly increased from 12% to 14% by increasing dosage of AE from 0.05% to 0.20%. Although target air content could be achieved by wide range of AE dosage (0.05-0.20%), there might be effect of each AE dosage on flowability of mortar. Accordingly, degree of interaction between model coarse aggregate and mortar was examined

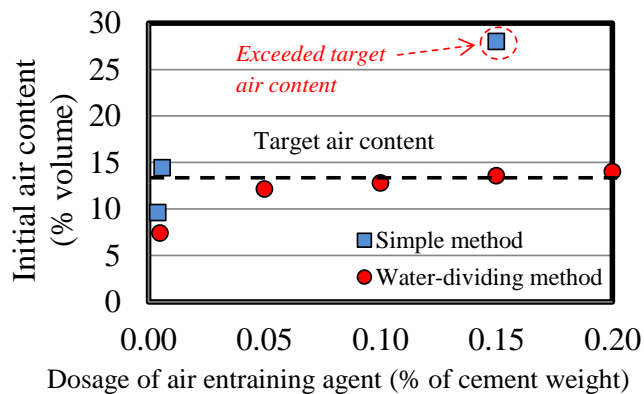

Fig. 3.8 Excessive dosage of AE was necessary to produce target air content for water dividing method

Fig. 3.9 shows the degree of interaction between model coarse aggregate and mortar ($I-R_{mb}/R_m$) of mortar in this series. The number on Fig. was dosage of AE in each mortar mix.

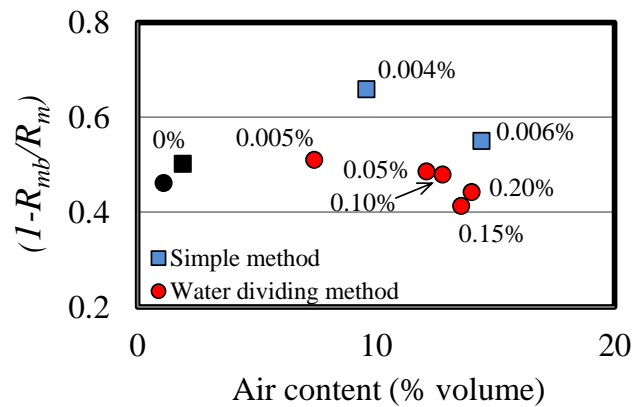

Fig. 3.9 ($I-R_{mb}/R_m$) decreased due to the increase in AE dosage in spite of similar air content

Consider the group of data in which s/m was approximately 50%, dosage of AE of over 0.05% was necessary for water dividing mixing method, whereas it was only 0.006% for simple mixing method. Entrained air was not effective by simple mixing method as mentioned in previous subsection. However the mitigation in $(I-R_{mb}/R_m)$ was observed in mortar mixed by water dividing mixing method with dosage of AE of over 0.15%.

The optimum dosage of AE was 0.15% that gave the best value of $(I-R_{mb}/R_m)$ as 0.413. $(I-R_{mb}/R_m)$ became 0.442 by increasing dosage of AE to be 0.20%. Despite the fact that dosage of AE of 0.05-0.20% could produce target air content, significant result was apparently observed. The variation in dosage of AE might result in different characteristic of entrained bubbles for flowability and self-compactability enhancement of mortar and concrete.

Although $(I-R_{mb}/R_m)$ was slightly mitigated to be approximately 0.41-0.42 by water dividing mixing method and Last adding AE mixing method, these values were the best among the other mortar mixes. Accordingly, mortar mix proportions with AE1 were selected to be verified with concrete experiment.

3.8 Verification of results of mortar with concrete experiment

To ensure that mix proportion of mortar can be mixed with real coarse aggregate for achieving self-compacting concrete, concrete experiment was performed. 3 mixing methods for were applied to concrete combining with normal and excessive dosage of air entraining agent. Water dividing mixing method and Last adding AE mixing method for concrete are shown in **Fig. 3.10** and **Fig. 3.11** respectively.

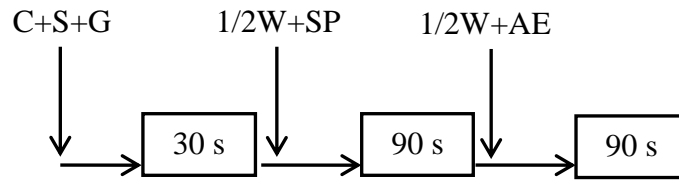

C : cement S : sand W : water G : Gravel SP : superplasticizer AE : air entraining agent

Fig. 3.10 Water dividing mixing method for concrete

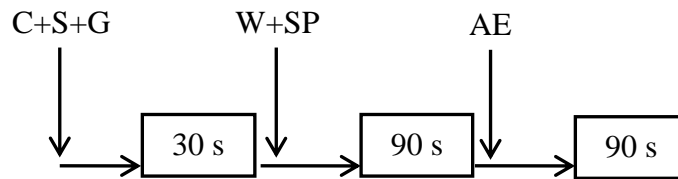

C : cement S : sand W : water G : Gravel SP : superplasticizer AE : air entraining agent

Fig. 3.11 Last adding AE mixing method for concrete

In case of concrete mixed by simple mixing method, mixing time after adding liquid materials was 180 seconds. Accordingly, mixing time of liquid materials divided into 2 parts was 90 seconds for each part in water dividing and Last adding AE mixing method.

Coarse aggregate used in experiment was crushed limestone with 2 classes of size. Those 2 classes were coarse aggregate with size in range of 5-15 mm and 15-20 mm. The ratio between size of 5-15 mm and 15-20 mm was constant as 6:4. Coarse aggregate content was 30% as the same as that of conventional self-compacting concrete. Water to cement ratio (W/C) was 45% following mortar experiment and sand to mortar ratio (s/m) was slightly lower than that of mortar which was 55% because target air content in concrete was

approximately 10%, thus designed s/m shall be 55% in order to keep s/m including air as approximately 50%. New-type superplasticizer (SP2) and air entraining agent type 1 (AE1) were used because the excellent result on mitigation of $(1-R_{mb}/R_m)$ was obtained by this combination. Normal and excessive dosage of AE were introduced in all of 3 mixing methods. Mix proportions of concrete are listed in **Table 3.4**.

Table 3.4 Mix proportions of concrete

Mixing method	W/C	s/m	c/a	SP	AE	AE dosage (% of cement)
Simple method						0.150
						0.005
Water dividing mixing method	45%	55%	30%	SP2	AE1	0.005
						0.050
						0.100
						0.150
						0.200
Last adding AE method						0.150

3.8.1 Initial air content

The target air content in concrete was aimed as approximately 10% which could be briefly estimated by air content in mortar with the same mix proportion. Air content in concrete was estimated as 70% of that in mortar because coarse aggregate content was fixed as 30% by volume in this research. Accordingly, the target air content in mortar was approximately 14-15%. **Fig. 3.12** shows the sufficient dosage of AE for producing target air content in mortar and concrete. It can be seen in mix proportion mixed by simple mixing method that initial air content in mortar and concrete was 9.4% and 14.4% by adding normal dosage of AE of 0.006% and 0.005% respectively. Those amount of air content almost reached target air content. Excessive dosage was also added to mortar and concrete mixes. Air content increased over target amount which was 28% and 15% in mortar and concrete respectively. In case of mortar and concrete mixed by water dividing mixing method that the target air content could not be produced by normal dosage, excessive dosage was necessary which was over 0.1%.

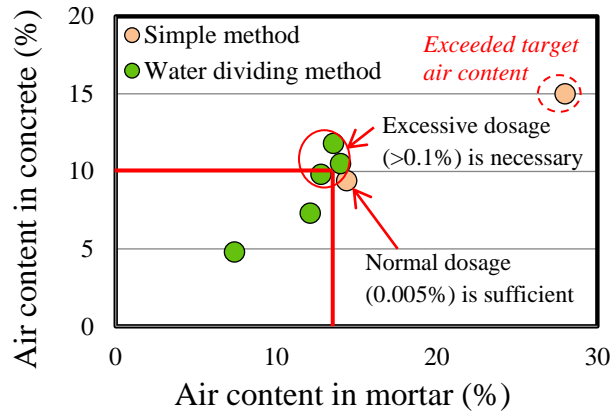

Fig. 3.12 Sufficient dosage of AE for producing target air content in mortar and concrete

High air content could be produced by simple mixing method because air entraining agent was added after mixing of cement and sand. This portion was stiff because no water was added in first step. Air entraining agent was added to portion with high friction thus amount of entrained air was effectively produced. Whereas 50% of water and superplasticizer were mixed with cement and sand before adding air entraining agent. This portion was softer than that of simple mixing method and internal friction was also low. Accordingly, excessive dosage was necessary for producing target air content.

3.8.2 Stability of air bubbles

Fig. 3.13 shows the stability of entrained air in concrete mixed by 3 mixing methods during 60 minutes after mixing. In case of concrete mixed by simple mixing method, initial air content was 9.4% and 15% by adding normal dosage (0.005%) and excessive dosage (0.15%) of air entraining agent respectively. Although target air content was achieved by normal dosage, air content decreased 4% in 60 minutes which was approximately 43%. On the other hand, air content slightly decreased in 60 minutes by adding excessive dosage of AE. Adding high amount of air entraining agent not only increased initial air content but also increased stability of entrained air because dosage of air entraining agent was sufficient for producing entrained air with low loss rate. This might be due to size of entrained bubbles which related to loss rate of air content.

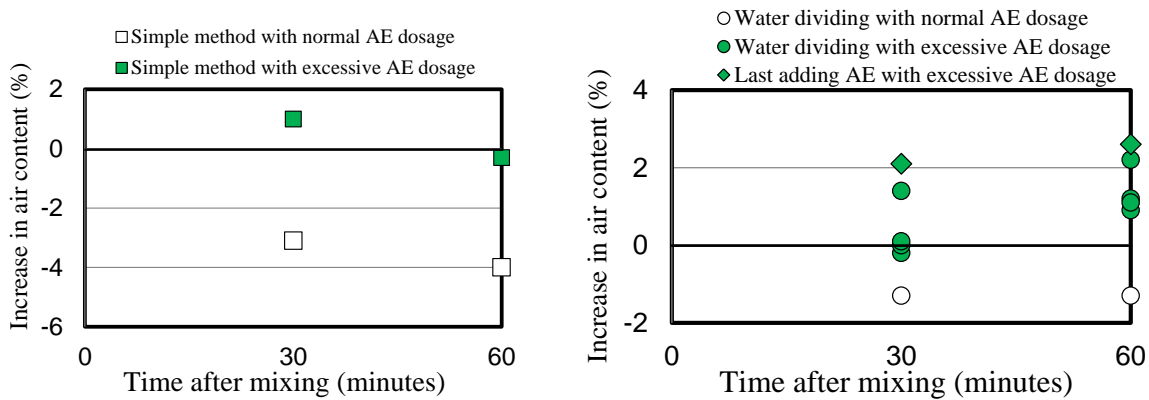

Fig. 3.13 Stability of entrained air improved by adding excessive dosage of AE

In case of concrete mixed by water dividing and Last adding AE mixing method, initial air content reached target amount by adding excessive dosage of air entraining agent over 0.10%. The increase in air content was observed in concrete with excessive dosage of AE. It increased approximately 1-2.5% in 60 minutes. The reduction in air content was observed only in concrete with normal AE dosage which decreased 1.3% in 60 minutes. However it decreased approximately 21% which was lower than that in concrete mixed by simple mixing method. Accordingly, it can be said that stability of entrained air could be improved by water dividing mixing method with excessive dosage of AE.

In fact, the increase in air content was not expected because air content directly affects compressive strength at hardened stage. Nevertheless, it is important to keep initial air content as approximately 10%. In addition to the reduction in compressive strength due to the presence of entrained air, compressive strength of self-compacting concrete with entrained air was minimally aimed as equal to compressive strength of normal concrete used for general reinforced concrete member which was approximately 25-30MPa. Accordingly, self-compacting concrete with air content in range of 11%-12.5% might be acceptable because compressive strength of self-compacting concrete itself was very high. To improve stability of entrained air, high amount of air entraining agent is necessary. However the saturated air content in concrete added excessive dosage of air entraining agent depended on mixing method which was approximately 15% by simple mixing method and 10% by water dividing or Last adding AE mixing method.

3.8.3 Self-compactability test of fresh concrete

Self-compactability of fresh concrete was tested by box test which was explained in chapter 2. Filling height of concrete increased due to the increase in air content which directly related to the reduction of aggregate content per unit volume in concrete matrix. However the different filling height was apparently observed although initial air content was similar. **Fig. 3.14** shows relationship between initial air content and the filling height which represents self-compactability of fresh concrete. Tendency of the increase of filling height of concrete mixed by simple mixing method significantly differed from that of concrete mixed by the other 2 mixing methods.

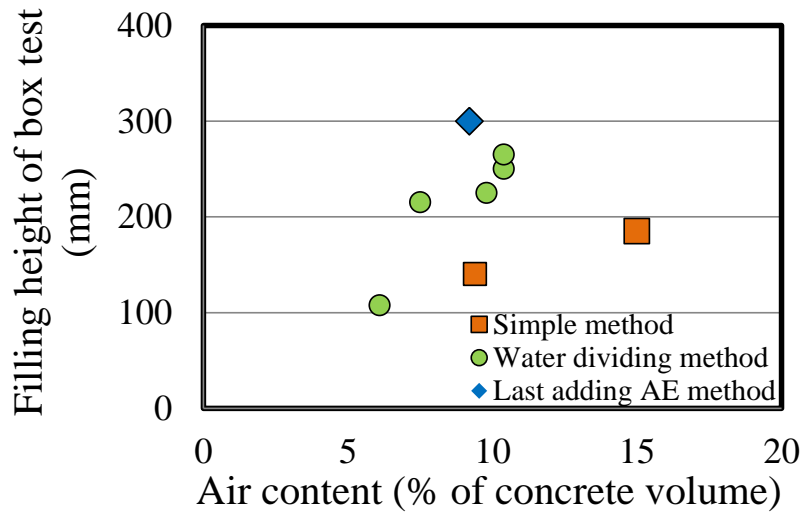

Fig. 3.14 Self-compactability improved by new mixing method

In cases of concrete mixed by simple mixing method, filling height could not reach 200mm. although air content was highest among the other mixes as 15%. It was 140mm. and 185mm. for concrete with air content of 9.4% and 15.0% respectively, as shown in **Fig. 3.15 a)**. The desirable filling height for self-compacting concrete is 250mm. Simple mixing method with employment of entrained air could not be used improved self-compactability of fresh concrete. Desirable self-compactability that filling height of over 250mm. was achieved by water dividing and Last adding AE mixing method with dosage of air entraining agent of over 0.15%. Filling height was 250mm. and 300mm. by water dividing and Last adding AE mixing method respectively, as shown in **Fig. 3.15 b)** and **Fig. 3.15 c)**. Although the air content of the mixes with AE of 0.1%, 0.15% and 0.2% were almost approximately as 10%, self-

compactability was apparently increased according to the increase in dosage of AE. In this case, the maximum filling height of concrete was 265 mm with the dosage AE of 0.20% of the cement weight. Moreover it reached 300mm. by Last adding AE mixing method Consider concrete with air content of approximately 10% which was the target amount of this research, filling height was obviously different due to mixing method. The improvement of self-compactability of SCC was succeeded by water dividing and Last adding AE mixing method with excessive dosage of air entraining agent. This combination produced preferable quality of entrained bubbles for improving not only durability of entrained air but also self-compactability of self-compacting concrete. Eventually, this mix proportion was used as the prototype of self-compacting concrete with low unit cement content called Air-enhanced self-compacting concrete (AirSCC).

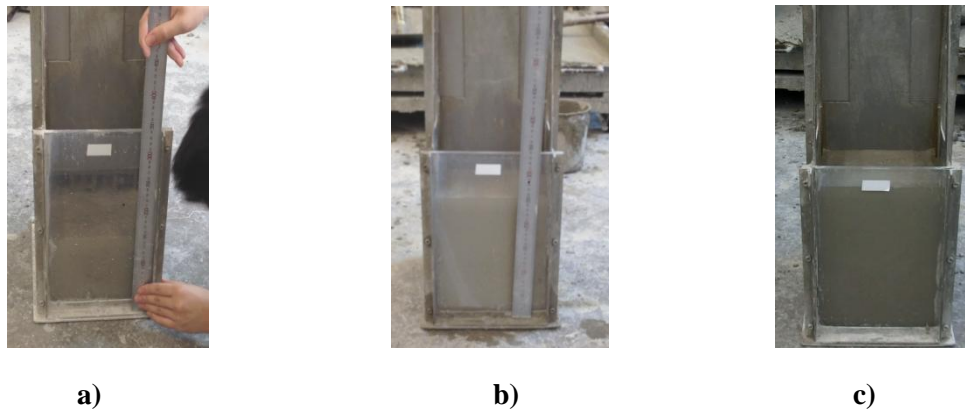

Fig. 3.15 Self-compactability test of fresh concrete

a) Simple mixing method with AE dosage of 0.005%

b) Water dividing method with AE dosage of AE 0.15%

c) Last adding AE method with AE dosage of AE 0.15%

3.8.4 Mix proportion of Air-enhanced self-compacting concrete (AirSCC)

According to self-compactability enhancement by entrained air, mix proportion of AirSCC with air content of approximately 10% can be proposed by using the designed parameters from concrete experiment in this chapter. Water to cement ratio (W/C) is 45% by weight which is the upper limit for SCC, Sand to mortar ratio (s/m) is 55% by volume. Coarse aggregate content is 30% of volume of concrete as the same as conventional SCC. Finally

superplasticizer and air entraining agent are 1.2% and 0.15% by weight respectively. Mix proportion of conventional SCC and AirSCC are listed in **Table 3.5**.

Table 3.5 Designed parameters of conventional SCC and AirSCC

Type of concrete	Designed parameters				
	W/C (%weight)	s/m (%volume)	Coarse aggregate content (%volume)	SP/C (%weight)	AE/C (%weight)
SCC (air content ~ 4%)	30	45	30	1.2	-
AirSCC (air content ~ 10%)	45	55	30	1.2	0.15

By using the designed parameters given in **Table 3.5**, unit weight of materials used for AirSCC can be calculated. Unit weight of materials used for conventional SCC and AirSCC in 1m³ of concrete volume are listed in **Table 3.6**. Cement weight in AirSCC is obviously lower than that of conventional SCC which is approximately 370kg/m³. Accordingly, superplasticizer can be reduced. Moreover amount of sand is approximately 120kg/m³ which is higher than that of conventional SCC.

Table 3.6 Mix proportion of conventional SCC and AirSCC

Type of concrete	Mass of materials (kg/m ³)					
	Cement	Water	Sand	Gravel	SP	AE
SCC (air content ~ 4%)	599	180	810	778	6.6	-
AirSCC (air content ~ 10%)	369	166	929	729	4.1	0.6

The difference of materials amount mentioned above resulted in low cost of AirSCC. Unit cost of AirSCC is approximately 9500 yen/m³ which is approximately 30% higher than unit cost of normal concrete. Whereas, unit cost of conventional SCC is approximately 14000 yen/m³ which is approximately 80% higher than unit cost of normal concrete. Vibrators are necessary for casting normal concrete, labor cost of normal concrete is approximately 400 yen/m³. Therefore, total cost of normal concrete including labor cost is approximately 8000 yen/m³, considering similar compressive strength at 30 N/mm². Total cost of each concrete for construction project is shown in **Fig. 3.16**.

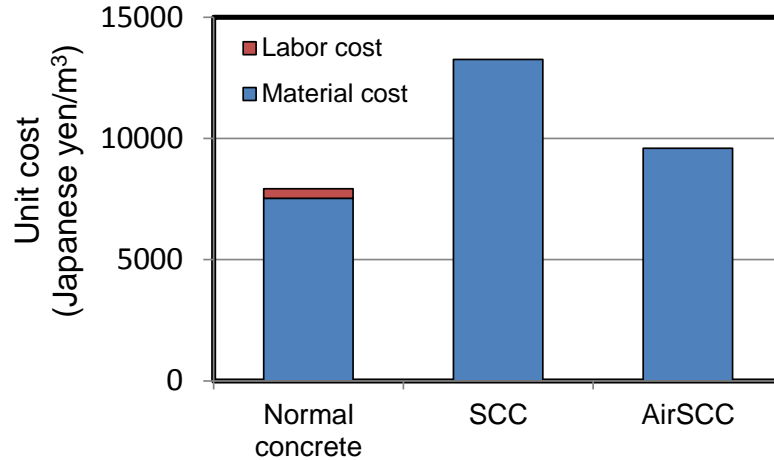

Fig. 3.16 Unit cost of AirSCC is slightly higher than that of normal concrete

3.8.5 Compressive strength of Air-enhanced self-compacting concrete (AirSCC)

One of the most important properties of concrete is compressive strength. Strength of concrete gradually decreased due to the increase in air concrete because of the loss of density itself. **Fig. 3.17** shows the reduction in compressive strength due to the increase in air content of AirSCC. The target air content of AirSCC is 10%. It can be seen that compressive strength is approximately 40N/mm^2 with air content of approximately 10%. Compressive strength of AirSCC is higher than compressive strength of normal concrete which is approximately 30N/mm^2 . Accordingly, it can be said that AirSCC is capable to be used for general reinforced concrete structures with moderate compressive strength.

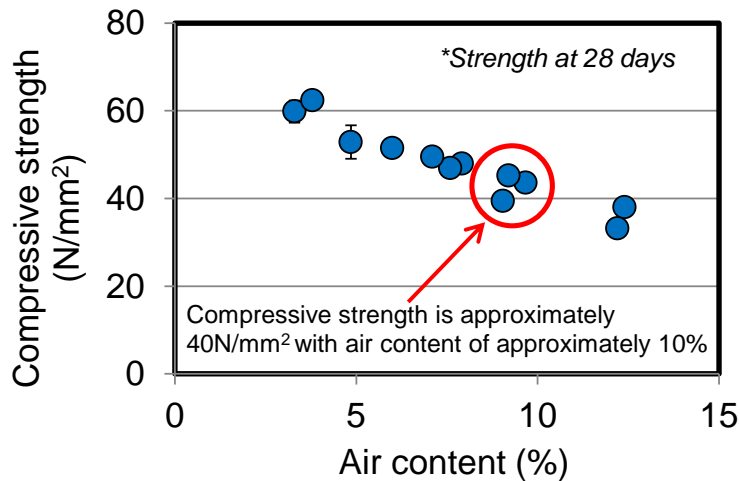

Fig. 3.17 The sufficient compressive strength of AirSCC with air content of 10%

3.9 Summary

It can be concluded in this chapter that Flowability of mortar and self-compactability of SCC was successfully improved by water dividing or Last adding AE mixing method at the excessive dosage of air entraining gent. Accordingly, fine aggregate content can be increased up to 55% resulting in effective reduction in unit cement content in mix proportion. Furthermore, volume of all materials automatically decreased due to the replacement of 10% of air content. Moreover, stability of entrained air was significantly improved by this effective mixing procedure simultaneously.

Finally, low cost self-compacting concrete with low unit cement content by employing entrained air has been created which is called Air-enhanced self-compacting concrete (AirSCC). This type of concrete has compressive strength approximately of 40N/mm^2 which is higher than that of normal concrete with W/C of 55% which is approximately 30N/mm^2 at 28days.

CHAPTER 4

EFFECT OF TOTAL SURFACE AREA OF ENTRAINED AIR ON REDUCTION IN FRICTION

4.1 Introduction

The purpose of this chapter is to clarify the enhancement of flowability and self-compactability of fresh concrete and mortar in terms of the total surface of entrained bubbles. This enhancement consists of 2 effects which are viscosity and ball bearing by entrained air. The author has set up a hypothesis in which effect of the presence of entrained air on the reduction rate of mortar with glass beads (R_{mb}). The R_{mb} of mortar with entrained air was compared with that of mortar without entrained air which represented degree of enhancement of flowability of mortar. The low reduction rate was expected to be occurred with high total surface area of entrained bubbles as shown in **Fig. 4.1** because high total surface results in high touching point between entrained bubbles and solid particles in mortar. Comparing the same air content in mortar, total surface of bubbles will be high when diameter of entrained bubbles is small. Accordingly, diameter of bubbles was measured in order to verify the hypothesis.

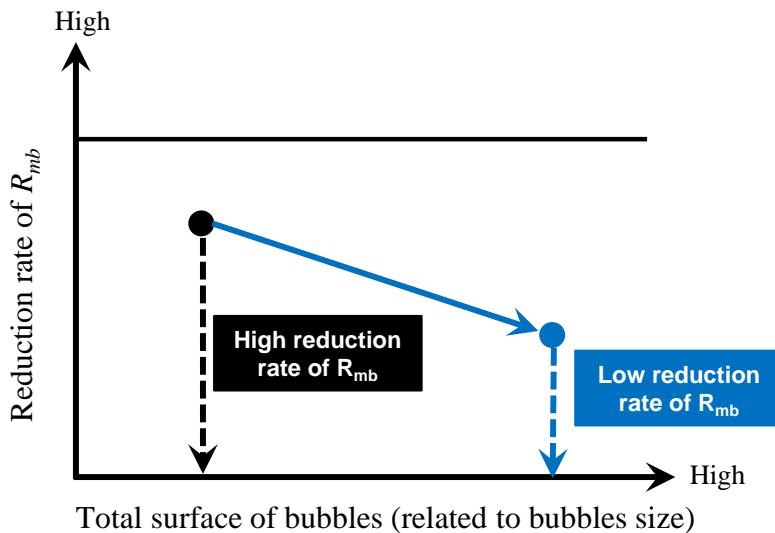

Fig. 4.1 High total surface area of bubbles results in low reduction rate of R_{mb}

As mentioned in the discussion in **Chapter 3**, flowability of mortar or self-compactability of fresh concrete was successfully improved by entrained air produced by the new type of mixing procedure. In spite of the same range of air content, the degree of self-compactability was apparently different which was high due to water dividing mixing method. Characteristic of bubbles entrained by the water dividing mixing method might differ from that by simple mixing method, which significantly affected flowability of mortar and self-compactability of concrete. This chapter presents the characteristic of entrained bubbles in mortar or concrete specimens at hardened stage and its effect on fresh properties of mortar and concrete. To measure characteristic of entrained bubbles in specimens, Linear Traverse Method (LTM) was performed according to ASTM C457 which is one-dimensional analysis, as shown in **Fig. 4.2**.



Fig. 4.2 Linear Traverse Machine

This traverse method is called “Modified Point-Count Method”. The average distance between stops was set as nearest 0.03. Total number that lead screw stop at air voids, cement paste and aggregate was counted and recorded in order to calculate the necessary data as follow.

- N = total number of air voids intersected,
- S_t = total number of stops,
- S_a = number of stops in air voids,
- S_p = number of stops in cement paste, and
- l = translation distance between stops

Total transverse length (T_t)

$$T_t = S_t \cdot l \quad (3)$$

Air content (A)

$$A = (S_a \cdot 100) / S_t \quad (4)$$

Cement paste content (p) in %

$$p = (S_p \cdot 100) / S_t \quad (5)$$

Cement paste-air ratio (p/A)

$$p/A = (S_p / S_a) \quad (6)$$

Void frequency (n)

$$n = N / T_t \quad (7)$$

Average chord length (\bar{l})

$$\bar{l} = (S_a \cdot l) / N \quad (8)$$

or

$$\bar{l} = A / 100n \quad (9)$$

Specific surface (α)

$$\alpha = 4 / \bar{l} \quad (10)$$

or

$$\bar{l} = 400n / A \quad (11)$$

The Spacing factor (\bar{L}) can be graphically estimated by use of **Fig. 4.3**.

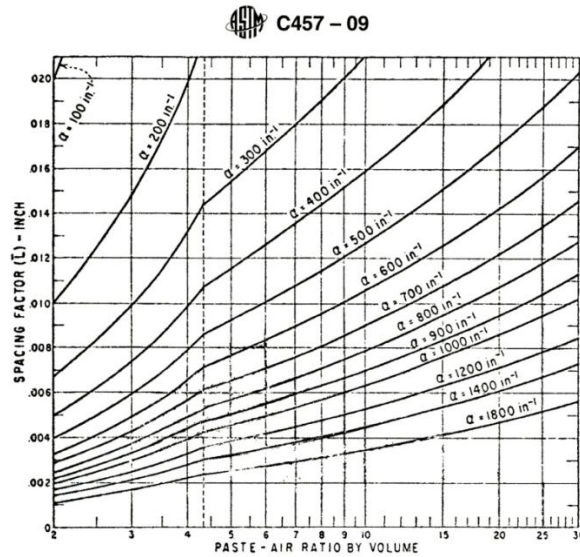

Fig. 4.3 Graph for estimating the Spacing factor (\bar{L})

Specimens were prepared according to standard size which was 100mm in diameter and 200mm in height for mortar specimens and 150mm in diameter and 300mm height for concrete specimens. The depth of specimens prepared for LTM was 50 mm. which was cut from cylinder specimens with 100mm and 150mm in diameter for mortar and concrete specimens respectively. In order to measure bubbles diameter on average, specimens were cut into 3 pieces represented characteristic of bubbles in top zone, middle zone and bottom zone of specimens. Cutting method of specimens is shown in **Fig. 4.4**. Air bubbles were measured on both sides of each piece of specimens, it means that 6 planes were measured for each specimens. Air content, diameter size of bubbles, number of bubbles and specific surface area were automatically calculated in accordance with ASTM C457 by computer program which has been installed and connected to measuring machine.

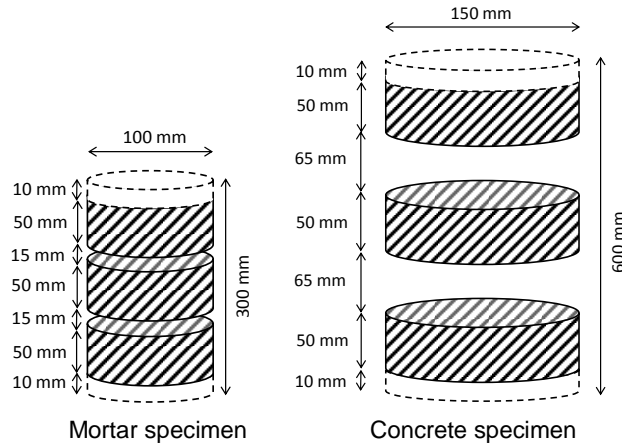

Fig. 4.4 Preparation of specimens for LTM

Mortar specimens mixed by simple and water dividing mixing method with superplasticizer types 1 and 2 were selected to measure characteristic of bubbles. Air entraining agent type 1 was selected because it was effective in mitigation of the degree of interaction between model coarse aggregate and mortar. Moreover excessive dosage of AE was used in mortar with water dividing mixing method. Mix proportion of mortar specimens are listed in **Table 4.1**.

Table 4.1 Mix proportion of mortar specimens for LTM

Mixing method	W/C	s/m	SP	AE	AE dosage (% of cement)
Simple mixing method	45%	57%	SP1	AE1	0.006
			SP2		0.006
SP1			0.010		
Water dividing mixing method			0.005		
			0.050		
			0.100		
			0.150		

4.2 Air loss in mortar during hardening

Air content at hardened stage significantly differed from that in fresh stage. It decreased approximately 2.3-4% except mortar specimen mixed by water dividing mixing method with new-type superplasticizer and AE dosage of 0.15%. In this mortar, air content decreased only 1.0% and the most effective mitigation in $(1-R_{mb}/R_m)$ was observed. The properties of effective entrained bubbles for self-compactability improvement might be similar to that of bubbles which can resist the loss of air during hardening. This might depend on diameter size of air bubbles. Air loss during hardening is shown in Fig. 4.5.

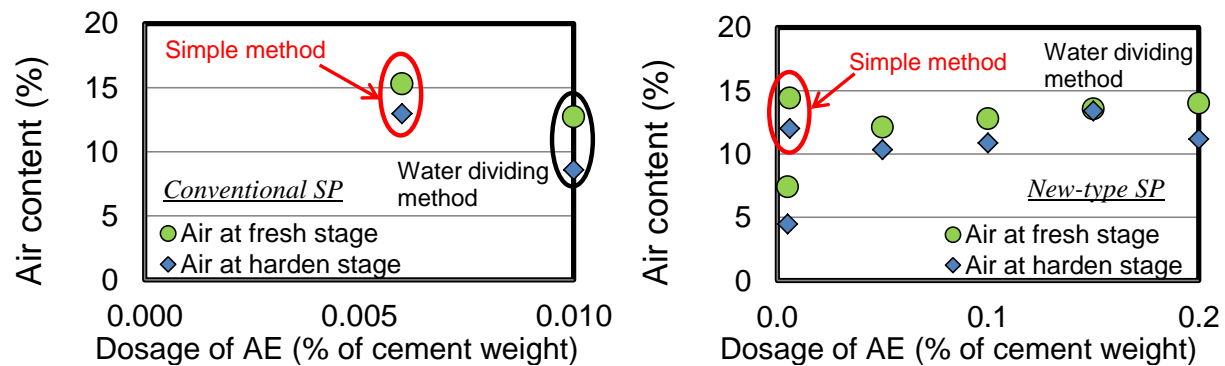

Fig. 4.5 Reduction of air content in mortar during hardening

4.3 Bubbles size distribution in mortar specimens

In this research, capillary pore was not considered because of its very small size which was smaller than 5µm. It could not be observed by visual observation. Moreover, the smallest size which can be detected by this measuring method is 10µm. Accordingly, air bubbles counted

by this machine were entrained air and entrapped air. Diameter size obtained from LTM was average values in each group of bubbles size. For example, air content of bubbles with diameter in range of 10-50 μm will be shown as the average diameter size of 25 μm . The largest air bubble was bubbles with 2.5mm. in average diameter. This size of air bubble was observed only in mortar with normal dosage of AE.

Mixing method and dosage of air entraining agent significantly affected the production process of entrained air. In spite of similar air content, diameter size of air bubbles produced by simple and water dividing method was apparently different. Bubbles size distribution in mortar specimens using SP1 and SP2 are shown in **Fig. 4.6** and **Fig. 4.7** respectively. Air content at hardened stage of mortar mixed by simple and water dividing method were 13.0% and 8.6%, as shown in **Fig. 4.6**. It can be seen that water dividing mixing method produced large amount of small bubbles, whereas large bubbles was slightly produced. On the other hand, large amount of large bubbles was produced by simple mixing method. Although air content of specimen mixed by water dividing mixing method was 8.6% which was lower than that of specimen mixed by simple mixing method which was 13%, volume of small air bubbles was close to each other. The difference in air volume mainly depended on air volume in zone of large bubbles size.

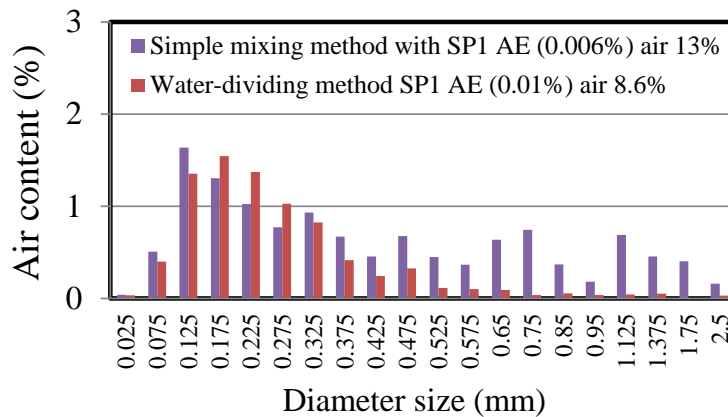

Fig. 4.6 Bubbles size distribution of mortar specimens using SP1

Fig. 4.7 shows bubbles size distribution of mortar specimens using SP2. In this case, air content produced by simple mixing method and water dividing mixing method were slightly different which were 12% and 13.4% respectively. Despite the fact that air content was

slightly different, bubbles size distribution was obviously different. Tendency of the distribution was similar to that of specimens with conventional superplasticizer that high volume of small air bubbles appeared in mortar with water dividing mixing method. And high volume of large air bubbles was observed in mortar with simple mixing method. The difference in bubbles size distribution of entrained air related to the reduction in degree of interaction between model coarse aggregate and mortar ($I-R_{mb}/R_m$). The effective reduction in degree of ($I-R_{mb}/R_m$) might be due to high amount of small air bubbles that could be seen apparently in case of mortar mixed by water dividing mixing method with SP2 and excessive dosage of AE.

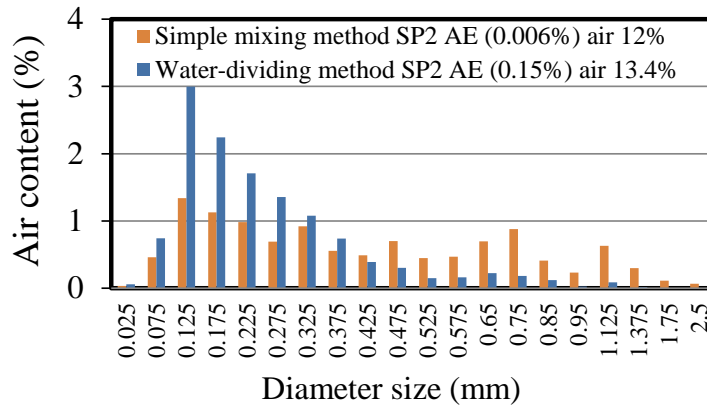

Fig. 4.7 Bubbles size distribution of mortar specimens using SP2

Large amount of small air bubbles was produced by water dividing mixing method in which air entraining was added at the last step. Small bubbles could be greatly produced in mortar with low friction condition by mixing half of water with superplasticizer before adding air entraining agent. However, high dosage of air entraining agent was necessary to produce target air content for new mixing method because of its low inside friction especially for mortar using new-type superplasticizer. There might be some part of air bubbles was destroyed by viscosity agent blended in new-type superplasticizer.

Furthermore, effect of excessive dosage of air entraining agent with water dividing mixing method on bubbles size distribution mortar was also studied because there was significant mitigation in ($I-R_{mb}/R_m$) by adding various excessive dosage of AE. **Fig. 4.8** shows bubbles size distribution of mortar mixed by water dividing mixing method with variation of excessive

dosage of air entraining agent. The tendencies of size distribution of mortar with excessive dosage of AE were almost similar, except mortar with AE dosage of 0.2%. Although AE dosage was added 0.2% but volume of small bubbles was obviously lower than that of mix added AE dosage of 0.05%, 0.10% and 0.15%. Moreover volume of large bubbles was higher than that of the others mixes. It was higher than that of mortar with AE dosage of 0.15%, although total air content was lower. This might be the results of adding overdose of air entraining agent to mix proportion that energy consumption of new mixing method was not sufficient for this dosage. It can be said that the optimum dosage of air entraining agent was 0.15% of cement weight in term of both mitigation in $(1-R_{mb}/R_m)$ and resistance to air loss during hardening.

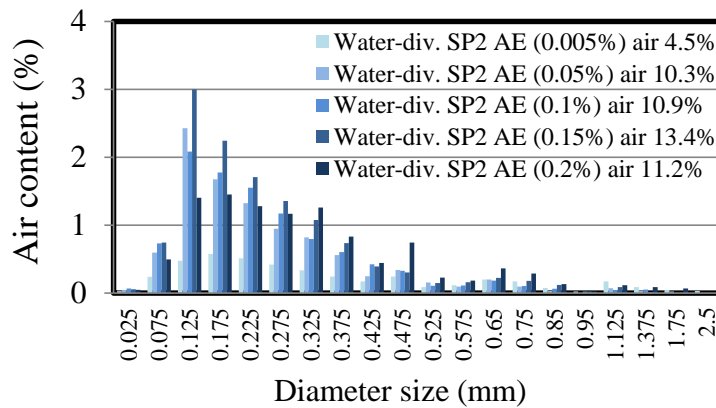

Fig. 4.8 Bubbles size distribution of mix proportions mixed by water dividing mixing method

Air content of mortar with dosage of AE of 0.005% was only 4.5% which was very low comparing to mortar with the dosage of AE of 0.006% with simple mixing method. This was also caused by soft condition of mortar before adding air entraining agent. Air content of over 10% was difficult to be produced in mortar with high flowability. Therefore excessive dosage of AE was necessary for achieving target air content which was in range of 10-13%. To achieve target air content, AE dosage over 0.05% was necessary. Although air content increased up to 13.4% by adding AE of 0.15%, it dropped as 11.2% by adding AE of 0.20%. In fact, initial air content of mortar added AE dosage of 0.20% was 14% which was higher than that of mix added AE of 0.15% which was 13.6%, however air loss during hardening was higher.

The example photos of air bubbles in mortar at harden stage measured by LTM are shown in **Fig. 4.9**. It can be seen that large bubbles were obviously observed in mortar specimens mixed by simple mixing method as shown in **Fig. 4.9 a)** and **Fig. 4.9 b)**. On the contrary, large bubbles were slightly observed in mortar specimens mixed by water dividing mixing method as shown in **Fig. 4.9 c)** and **Fig. 4.9 d)**.

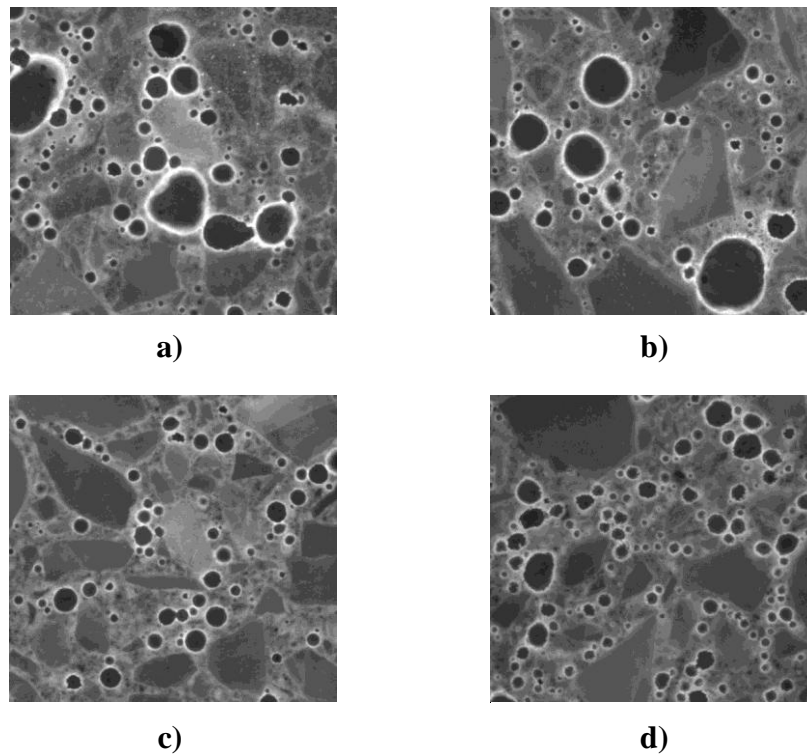

Fig. 4.9 Example photos of air bubbles in mortar specimens
a) Simple method with SP1 and AE 0.006% (air 13.0%)
b) Simple method with SP2 and AE 0.006% (air 12.0%)
c) Water dividing method with SP1 and AE 0.01% (air 10.9%)
d) Water dividing method with SP2 and AE 0.15% (air 13.4%)

The mechanism of flowability and self-compactability enhancement by entrained air was explained as ball bearing effect in **Chapter 2**. Image of the presence of large bubbles in mortar is shown in **Fig. 4.10 a)**. It can be seen that there are large gap between air bubbles inside mortar matrix comparing to gap between air bubbles in case of small bubbles.

Comparing number of bubbles with the same air volume, once diameter of air bubbles become half of large bubbles, number of bubbles becomes 8 times according to equation (3). Moreover, total surface of bubbles will be higher which is one of the important factors on flowability and self-compactability enhancement. The image of distribution of small air bubbles in mortar is shown in **Fig. 4.10 b)**. High amount of bubbles appeared among sand particles and model coarse aggregate which effectively enhanced flowability of mortar. Furthermore touching surface between air bubbles and solid particles was high due to large amount of bubbles which resulted in effective enhancement of flowability of mortar.

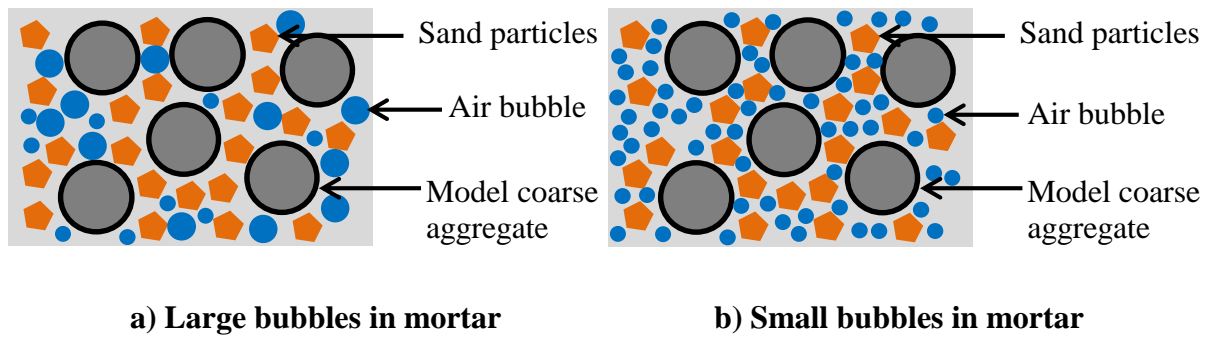

Fig. 4.10 Number of bubbles in mortar with different size, considered the same air content

$$V_{sphere} = \frac{4}{3} \pi r^3 \quad (12)$$

where, V_{sphere} : Volume of air bubbles
 r : Radius of bubbles

4.4 Rate of reduction in funnel speed of mortar with glass beads (R_{mb}) due to the presence of entrained air

The rate of reduction in the funnel speed of mortar with glass beads (ΔR_{mb}) due to entrained air was employed as an index for effect of entrained air on the flowability of glass beads in mortar. This reduction rate means the mitigation in reduction of R_{mb} by entrained air which was calculated from the different value of R_{mb} between mortar with entrained air and without entrained air. Once entrained was produced in mortar, R_{mb} reduced because funnel speed

reduced due to water retention by entrained air. Therefore, low rate of reduction in R_{mb} is equivalent to high flowability of glass beads. On the other hand, high rate of reduction of R_{mb} is equivalent to low flowability of glass beads. as shown **Fig. 4.11**.

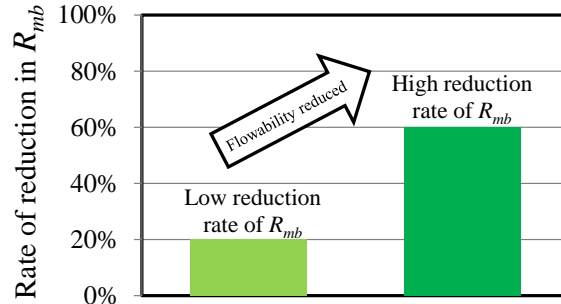

Fig. 4.11 Rate of reduction in R_{mb} representing flowability of mortar

Fig. 4.12 shows the rate of reduction in R_{mb} regarding to AE dosage and mixing method. Dosage of AE of over 0.05% was necessary for mortar with water-dividing mixing method, whereas it was only 0.005% for simple mixing method. Entrained air was not effective by simple mixing method. However, low reduction rate of R_{mb} was observed in mortar mixed by water-dividing mixing method with dosage of AE of over 0.15%.

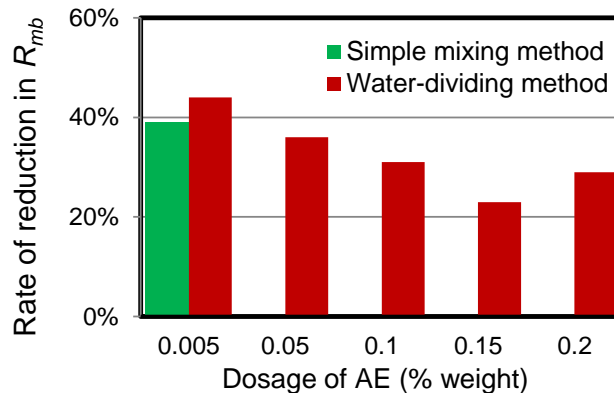

Fig. 4.12 Low rate of reduction in R_{mb} due to the presence of entrained air with water-dividing mixing method in mortar using conventional superplasticizer

The optimum dosage of AE was 0.15% which resulted in the lowest value of the reduction rate of R_{mb} as 22%. It became 29% by increasing dosage of AE to be 0.20%. Despite the fact that dosage of AE of 0.05-0.20% could produce target air content, different result was

apparently observed. The variation in dosage of AE might result in different characteristic of entrained bubbles for flowability and self-compactability enhancement of mortar and concrete. Although the reduction rate of R_{mb} was slightly over 20% by water-dividing mixing method, this values was the best among the other mortar mixes.

Fig. 4.13 shows the rate of reduction in R_{mb} regarding to total surface area of entrained bubbles. The rate of reduction of R_{mb} tended to reduce according to the increase in total surface area of bubbles. Total surface area of bubbles was low by simple mixing method which was approximately $263\text{mm}^2/\text{mm}^3$ comparing to water dividing method. Total surface area gradually increased due to the increase in AE dosage in mortar mixed by water dividing method which was maximum at $418\text{mm}^2/\text{mm}^3$ with AE dosage of 0.15%. However, it was reduced from $418\text{mm}^2/\text{mm}^3$ to $293\text{mm}^2/\text{mm}^3$ by increasing AE dosage from 0.15% to 0.20% resulted in the increase in rate of reduction of R_{mb} . It can be said that AE dosage of 0.15% was optimum value for producing high total surface area of bubbles with water dividing mixing method.

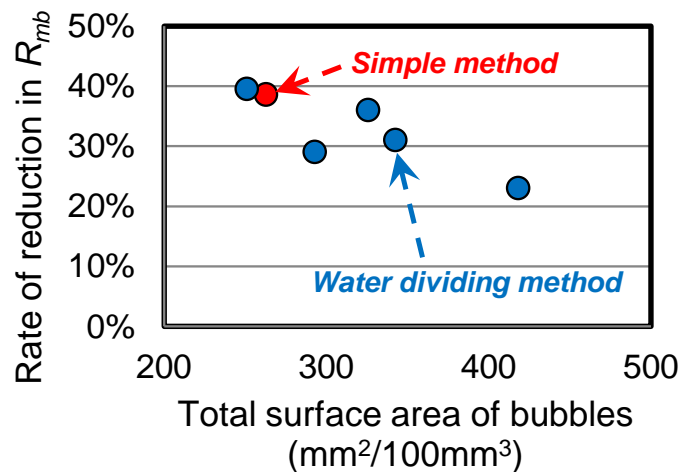

Fig. 4.13 Low rate of reduction in R_{mb} due to high total surface area of entrained bubbles

The interaction between model coarse aggregate and mortar ($1-R_{mb}/R_m$) was effectively reduced by entrained air produced by water-dividing mixing method as shown in **Fig. 4.14**. It almost reached 0.4 which was the desirable value for mortar that can be mixed with real coarse aggregate to be SCC. On the other hand, it apparently increased by simple mixing method in spite of slightly different air content. The preferable characteristic of entrained

bubbles for flowability of mortar could be produced by water-dividing mixing method.

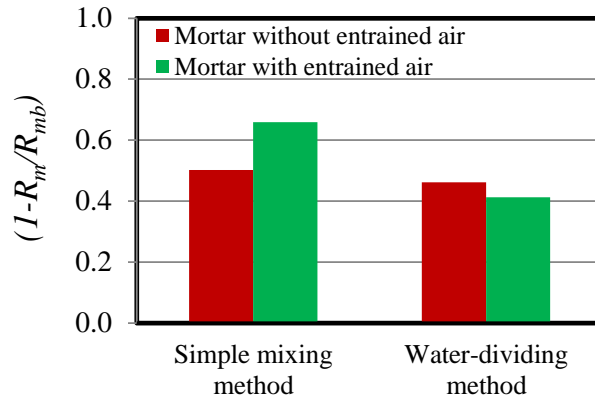

Fig. 4.14 Mitigation in $(1-R_m/R_m)$ due to the presence of entrained air

Fig. 4.15 shows the degree of $(1-R_m/R_m)$ regarding to total surface area of entrained bubbles. $(1-R_m/R_m)$ gradually reduced according to the increase in total surface area. $(1-R_m/R_m)$ almost reached the desirable value of self-compacting mortar which was 0.4 with total surface of approximately $418 \text{ mm}^2/100\text{mm}^3$. To achieve high total surface area of bubbles, water-dividing method with excessive dosage of AE was necessary. The optimum AE dosage was 0.15%, total surface area reduced to be approximately $293 \text{ mm}^2/100\text{mm}^3$ by adding AE dosage of 0.20%. Total surface area could not over $300 \text{ mm}^2/100\text{mm}^3$ by simple method, it was approximately $263 \text{ mm}^2/100\text{mm}^3$ with air content of $11.5 \text{ mm}^2/100\text{mm}^3$ in this study.

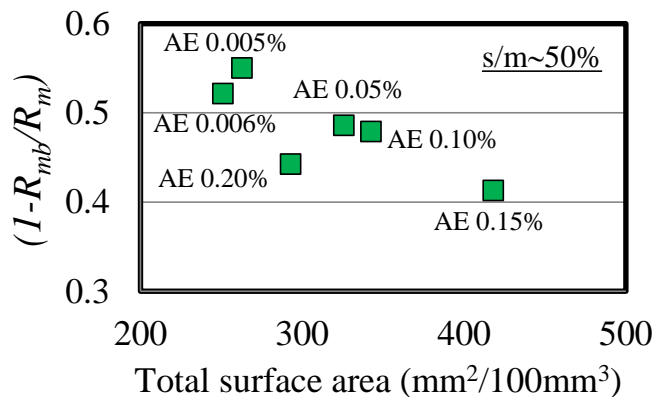

Fig. 4.15 Degree of $(1-R_m/R_m)$ due to total surface area of bubbles

It can be seen that the relationship between total surface area of bubbles and $(1-R_m/R_m)$ seem

to be linear relation. However, point of mortar with AE dosage of 0.2% was out of the trend. It might be due to the error in measuring procedure. Accordingly, air content at hardened stage was measured by weight and compared with air content measured by LTM. **Fig. 4.16** shows the error of measuring air content by LTM. It can be seen that air content measured by weight of mortar with AE dosage of 0.00%, 0.05%, 0.10% and 0.015% slightly differed from that by LTM which was lower than 1.0%. Air content of mortar with AE dosage of 0.20% measured by LTM apparently differed from that by weight which was approximately 2.5%. Undetectable bubbles might be existed in this case. This error resulted in low total surface area of bubbles in mortar with AE dosage of 0.20% that made data out of linear relation in **Fig. 4.13** and **Fig. 4.15**.

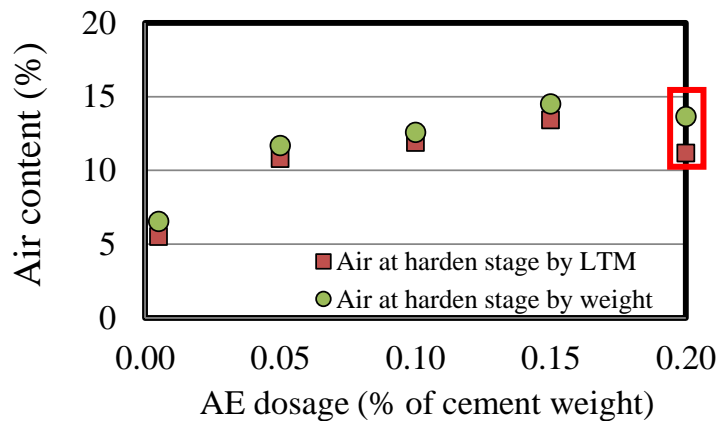

Fig. 4.16 Significant difference of air content measured by weight and LTM of mortar with AE dosage of 0.2%

4.5 Mechanism of mixing method and the presence of entrained air and on enhancement in flowability of mortar

Effect of mixing method and entrained air were considered in terms of the variation in funnel speed of mortar (R_m) and mortar with funnel speed (R_{mb}). **Fig. 4.17** shows the different value of R_{mb} and R_m between mortar mixed by simple method and water dividing method. Moreover, different value of R_{mb} and R_m between mortar with entrained air and without entrained air were compared as well. It can be seen that funnel speed of mortar and mortar with glass beads increased due to water dividing mixing method as shown in A zone. In case of mortar mixed by water dividing mixing method, half amount of water with superplasticizer was added and

mixed with solid materials for 1min. Cement paste in this portion could not make mortar flowable because of insufficient water, it separately covered fine aggregate. At this point, superplasticizer was effectively catalyzed due to high friction with dry condition of mortar. Then another half of water was added to mortar and mixed for 1min. In spite of the same mixing time of liquid materials which was 2mins in both simple and water dividing method, R_{mb} and R_m of mortar with water dividing method was higher because superplasticizer was catalyzed at the first step.

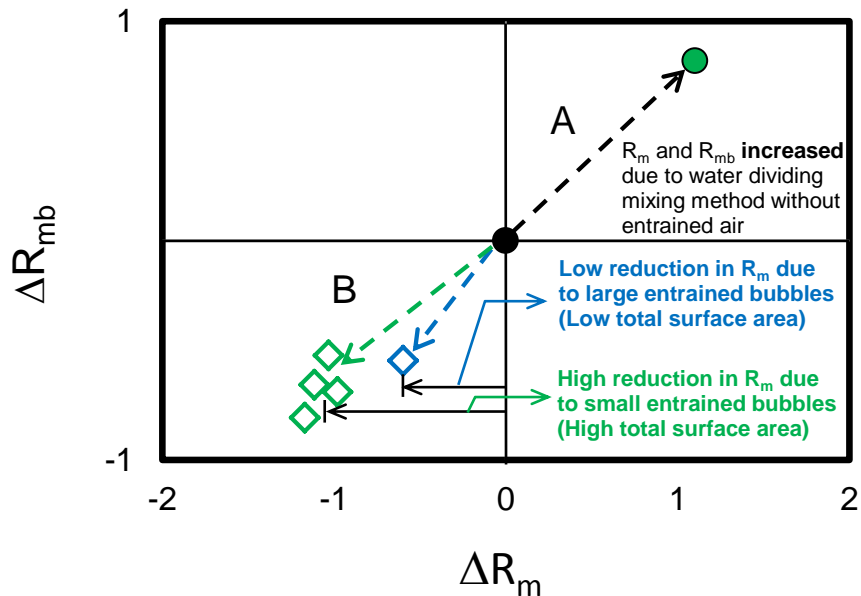

Fig. 4.17 Effect of mixing method and the presence of entrained air on R_m and R_{mb}

On the other hand, R_{mb} and R_m reduced due to the presence of entrained air because of water retention as shown in B zone. Entrained bubbles absorbed free water in mortar matrix which resulted in reduction in funnel speed of mortar. The degree of reduction in R_{mb} and R_m depended on total surface area of bubbles which related to mixing method and dosage of air entraining agent. It can be seen that the reduction in R_{mb} and R_m was low in mortar with simple mixing method which produced large size of bubbles. And it was high in group of mortar mixed by water dividing mixing method with excessive dosage of air entraining agent which produced small size of bubbles as mentioned in previous subchapter. The reduction in R_m due to water retention by entrained air is shown in **Fig. 4.18**. It can be seen that s/m and W/C of mortar was constant as 57% and 45% respectively. The reduction in R_m in these mortar

occurred by water retention because original free water was similar in all mixes. The degree of reduction in R_m depended on characteristics of entrained bubbles involving mixing method and air content. It can be seen that the degree of water retention in mortar mixed by water dividing method was larger than that in mortar mixed by simple method because of larger amount of small bubbles resulting in high total surface area.

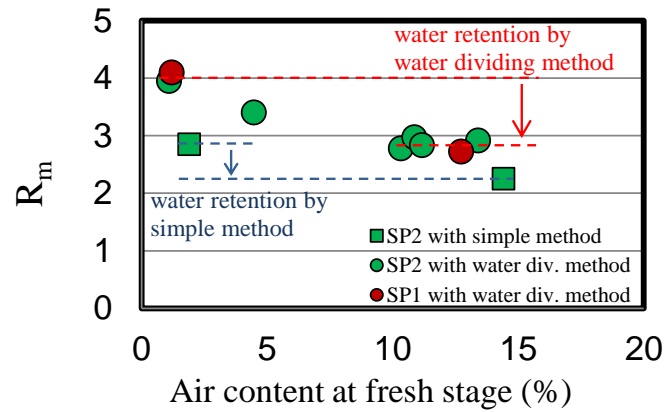

Fig. 4.18 The reduction in funnel speed due to the presence of entrained air

The degree of water retention depended on total surface of bubbles which significantly related to diameter size of entrained bubbles. **Fig. 4.19** shows the total surface of entrained bubbles which was separately considered for each size of bubbles. It can be seen apparently that the effective diameter size on total surface was small bubbles especially bubbles with diameter smaller than 0.3mm. The shared surface of bubbles with diameter smaller than 0.3mm. was approximately 75% in mortar mixed by simple method and 90% in mortar mixed by water dividing method as shown in **Fig. 4.20**. This resulted in high reduction in degree of water retention by entrained air according to water dividing mixing method.

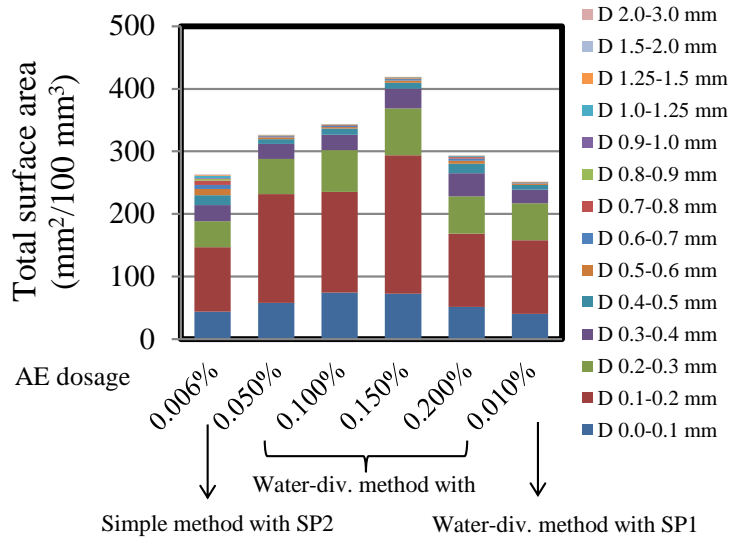

Fig. 4.19 Total surface of bubbles of each diameter size

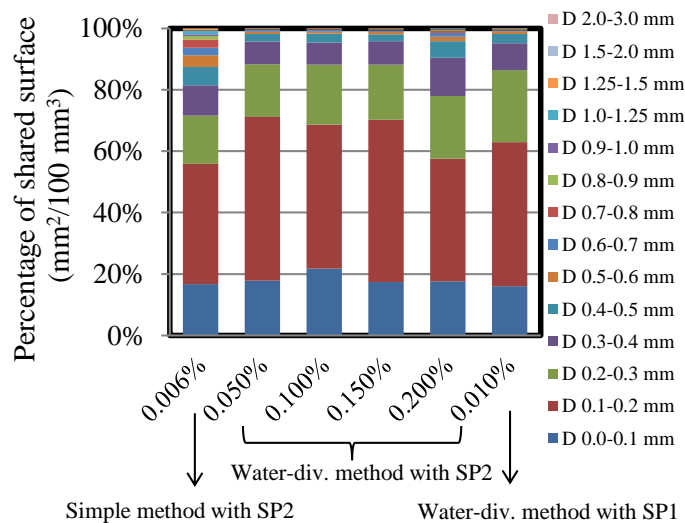

Fig. 4.20 Percentage of shared surface of bubbles in mortar

In spite of similar air content in mortar, total surface of entrained bubbles was different due to the characteristic of bubbles itself. **Fig. 4.21** shows relationship between air volume and total surface of bubbles in mortar with different mixing method. In mortar mixed by water dividing method, total surface of bubbles gradually increased due to the increase in air volume. This relation was almost linear because the percentage of shared surface of each size of bubbles was almost similar. Total surface of bubbles in mortar mixed by simple method was totally different from that in mortar mixed by water dividing method. It can be seen that total surface of bubbles was approximately $262\text{mm}^2/100\text{mm}^3$ with air volume of approximately

11.5mm³/100mm³ whereas it was approximately 350mm²/100mm³ with air volume of approximately 10.2mm³/100mm³ in mortar mixed by water dividing method.

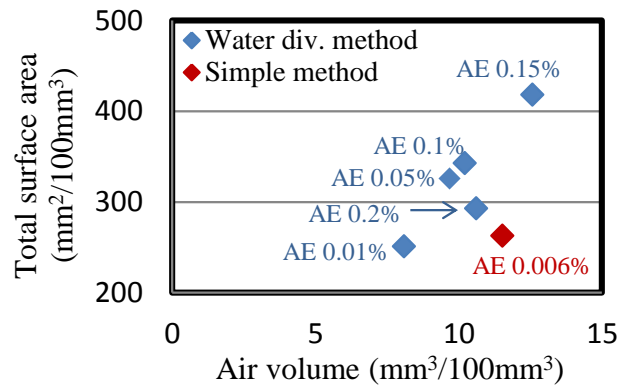

Fig. 4.21 Large total surface area of bubbles due to water dividing mixing method

Once effect of water dividing mixing method called mortar effect was combined with effect of entrained air, the increase in funnel speed of mortar is shown in **Fig. 4.22**. Mortar with small bubbles entrained by water dividing mixing method with AE dosage of 0.15% was selected because it resulted in lowest degree of interaction between model coarse aggregate and mortar ($1-R_{mb}/R_m$).

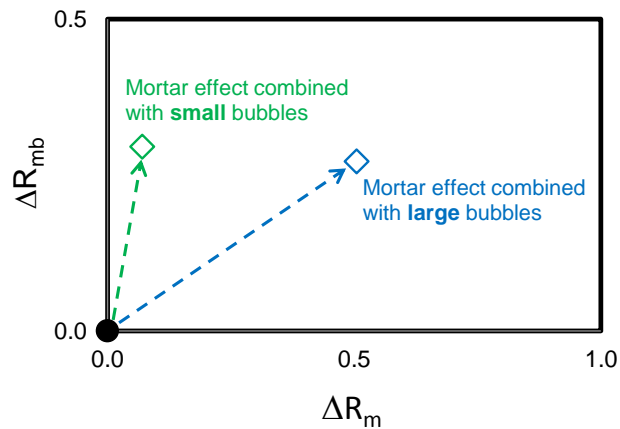

Fig. 4.22 Combination of mortar effect and effect of entrained air on the increase of R_{mb} and R_m

In case of mortar with large bubbles, R_m increased approximately 0.5 and this resulted in the increase in R_{mb} of approximately 0.25. It seemed like tendency of mortar effect by water dividing mixing method as shown in **Fig. 4.17**. Effect of large entrained bubbles on R_{mb} and

R_m might not exist because it moved due to normal stress approached by aggregate during deformation as shown in **Fig. 4.23**. On the contrary, R_m slightly increased in mortar with small bubbles. However, R_{mb} significantly increased approximately 0.3 because of flowability enhancement by entrained bubbles. It can be said that small bubble was effective on flowability enhancement of mortar with model coarse aggregate. Small bubbles could resist normal stress during deformation and produced rebound forces inside mortar matrix as shown in **Fig. 4.24**.

By assuming that thickness of surface of large and small bubbles was the similar, thus the aspect ratio (thickness/diameter) of small bubbles was higher than that of large bubbles. It means that small bubble was capable to resist or absorb the compression forces due to the approaching of model coarse aggregate during deformation. **Fig. 4.23** shows the behavior of large bubbles when it was compressed by coarse aggregate. Shape of bubbles was considerably changed by compression forces according to thin surface (low aspect ratio). Therefore bubbles tried to move away from the original position. Once bubbles have already moved away, coarse aggregate were hit each other and produced friction forces in mortar matrix.

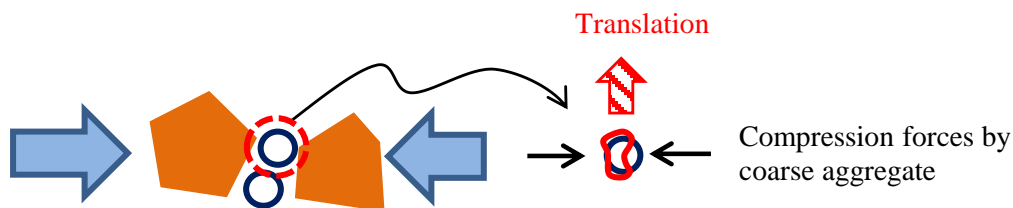

Fig. 4.23 Large bubbles is compressed by aggregate

Contradictory, small bubbles with high aspect ratio effectively resisted compression forces during deformation, as shown in **Fig. 4.24**. Small bubbles slightly deformed due to the approaching of coarse aggregate, however bubbles with thick surface could resist compression forces and also reacted to coarse aggregate by rebounding force. This reaction is a part of ball bearing effect which enhance flowability and self-compactability of fresh concrete.

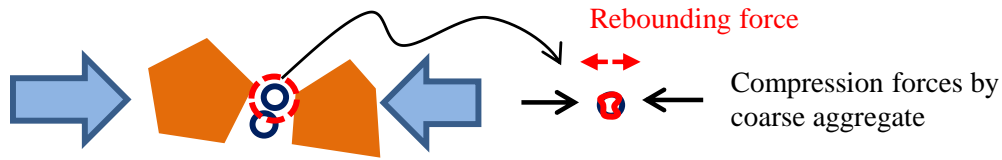

Fig. 4.24 Small bubbles is compressed by aggregate

4.6 Bubbles size distribution of entrained bubbles in concrete specimens

Bubbles size distribution in concrete specimens also depended on mixing method and dosage of AE added to mix proportions. In case of concrete with AE dosage of 0.005% of cement weight, bubbles size distribution by simple and water dividing mixing method were compared as shown in **Fig. 4.25**. It can be seen that volume of small air bubbles of concrete mixed by simple mixing method was slightly higher than that of concrete mixed by water dividing mixing method in spite of lower total air content. This resulted in higher filling height of box test. Filling height of concrete mixed by simple and water dividing mixing method was 140 mm and 108 mm respectively. Despite the fact that air content of concrete mixed by water dividing mixing method was higher which was 5.4% but volume of effective bubbles on self-compactability enhancement was slightly lower. Therefore filling height of concrete mixed by simple method was higher than that of concrete mixed by water dividing mixing method. However filling height could not reach 250 mm, thus excessive dosage of AE was added and mixed by both mixing methods.

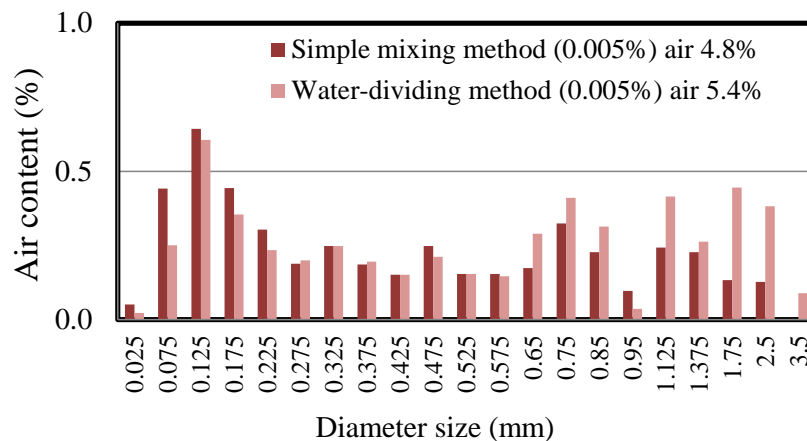

Fig. 4.25 Bubbles size distribution of entrained air using AE dosage of 0.005%

Fig. 4.26 shows bubbles size distribution of concrete with excessive dosage of AE of 0.15%. These distributions were similar to that of mortar specimens that volume in zone of large bubbles was slightly produced. Air volume in zone of small bubbles of specimen mixed by water dividing mixing method was higher than that of specimen mixed by simple mixing method, resulted in higher filling height of box test which were 250 mm and 185 mm. excessive dosage of AE with water dividing mixing method. It can be said that self-compactability of fresh concrete could be improved by water dividing mixing method with excessive dosage of AE. Eventually, the desirable filling height for SCC was achieved by this combination.

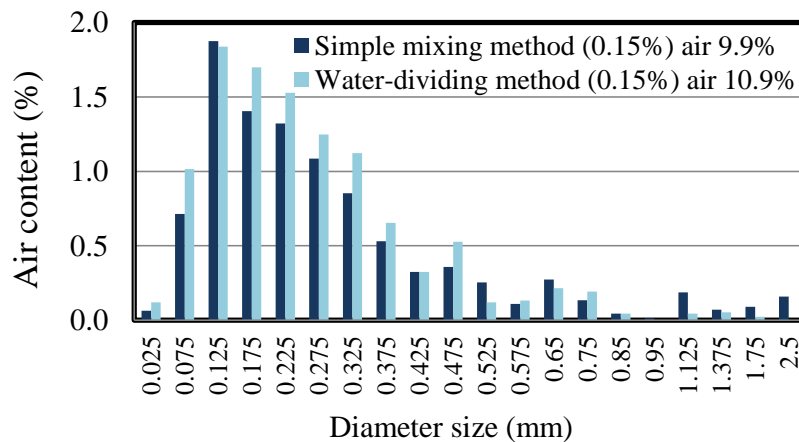

Fig. 4.26 Bubbles size distribution of entrained air using AE dosage of 0.15%

The comparison of bubbles size distribution of specimens mixed by water dividing mixing method with various dosage of AE is shown in **Fig. 4.27**. Dosage of air entraining agent was varied as 0.005%, 0.05%, 0.10% and 0.15%. Bubbles size distribution tended to be similar that volume of bubbles with diameter size larger than 0.5mm was rarely produced, except specimen with AE dosage of 0.005%. High amount of large bubbles was produced by adding normal dosage of AE, although air content of concrete with AE dosage of 0.005% was lowest, volume of large bubbles was highest among this group of specimens. In concrete with excessive dosage of AE (AE dosage over 0.05%), volume of all size of bubbles tended to be levelly increased due to the increase in air content. At this point, self-compacting concrete with air content of approximately 11% and sufficient self-compactability which was over 250mm. has been achieved. This type of concrete is named as Air-enhanced self-compacting concrete (AirSCC).

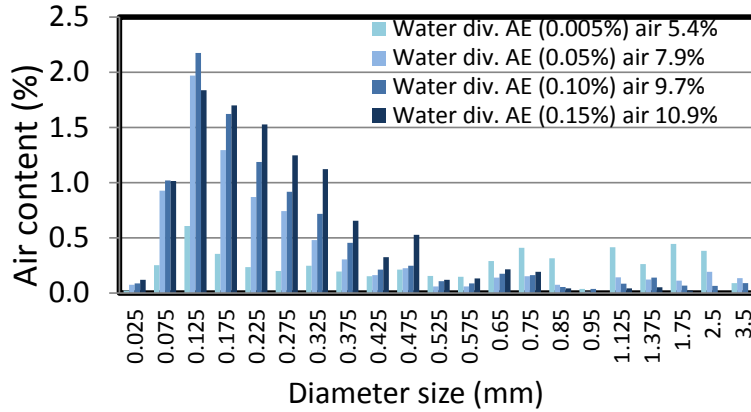

Fig. 4.27 Bubbles size distribution of entrained air by water dividing mixing method

4.7 Total surface of entrained bubbles in concrete specimens

Total surface area of entrained bubbles in concrete depended on mixing method which was similar to result of mortar. **Fig. 4.28** shows the total surface area considering each size of bubbles. Total surface area of concrete with normal AE dosage (0.005%) was small because of low air content which were 4.8% and 5.4% by simple and water dividing mixing method respectively. By using excessive dosage of AE with simple mixing method, air content was 9.9% with total surface area of 312.8 mm²/mm³. Total surface area gradually increased from 298.4-374.0 mm²/mm³ due to the increase in air content from 7.9-10.9% by increasing AE dosage from 0.05-0.15% in concrete with water dividing mixing method.

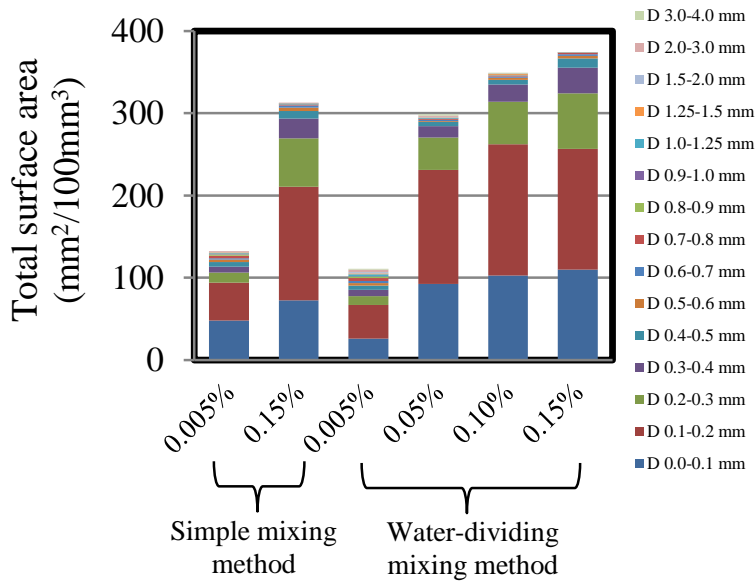

Fig. 4.28 Total surface area of bubbles of each diameter size in concrete

Volume of small bubbles significantly influenced the total surface area especially diameter smaller than 0.3mm as shown in **Fig. 4.29**. The shared surface of bubbles with diameter smaller than 0.3mm was approximately 70-80% by using normal AE dosage. It was approximately 85-90% in concrete with excessive dosage of AE mixed by both mixing method.

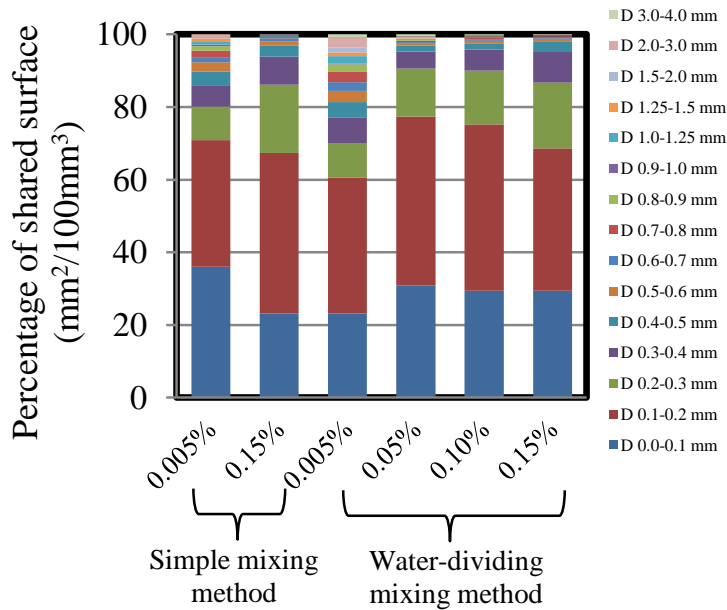

Fig. 4.29 Percentage of shared surface of bubbles in concrete

Large amount of total surface area was produced by water dividing mixing method in spite of similar air volume of approximately 10% comparing with concrete with simple mixing method as shown in **Fig. 4.30**. Consider similar air volume at approximately 10%, total surface area in concrete with water dividing mixing method was $374 \text{ mm}^2/100\text{mm}^3$, and it was $312.8 \text{ mm}^2/100\text{mm}^3$ in concrete with simple mixing method.

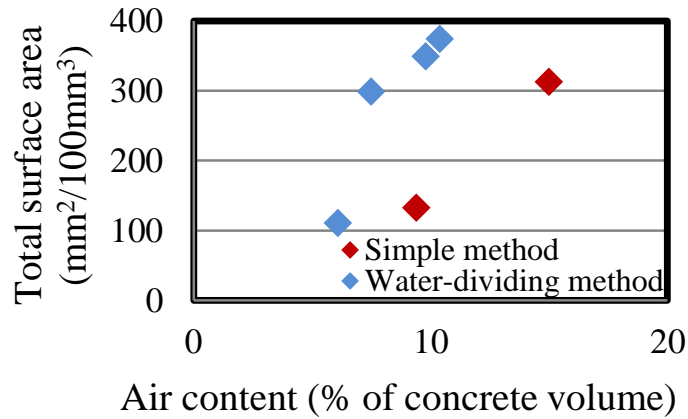

Fig. 4.30 Total surface of bubbles in concrete

Total surface area significantly related to self-compactability of concrete as shown **Fig. 4.31**. Filling height of concrete gradually increased due to the increase in total surface area of bubbles. The desirable self-compactability with filling height of 250mm was achieved in concrete with total surface of approximately $374 \text{ mm}^2/100\text{mm}^3$ which was produced by water dividing mixing method with excessive dosage of AE.

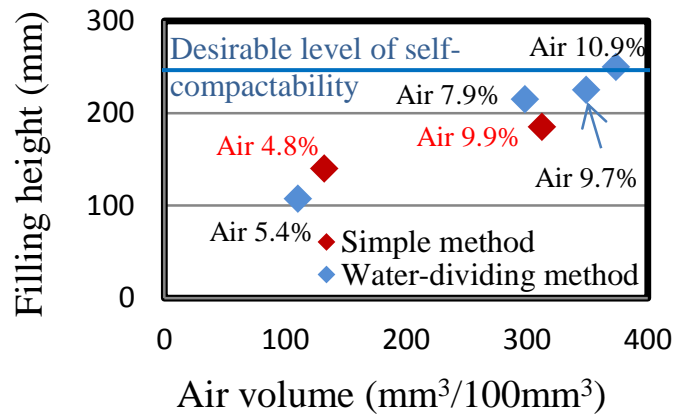

Fig. 4.31 Total surface area significantly related to self-compactability of concrete

4.8 Summary

It can be concluded that the effective entrained bubbles on flowability and self-compactability improvement was small bubble which could be produced by water dividing mixing method with excessive dosage of air entraining agent. Effect of entrained air on flowability of mortar was considered as 2 phases which were the reduction in funnel speed of mortar (R_m) and

mortar with model coarse aggregate (R_{mb}) by water retention and the increase in R_{mb} and R_m due to water dividing mixing method. Despite the fact that R_m slightly increase by combination of mortar effect and small entrained bubbles, R_{mb} significantly increase due to the internal bounding forces by small entrained bubbles.

Moreover, the sufficient total surface area for achieving desirable self-compactability was clarified which was approximately $374 \text{ mm}^2/100\text{mm}^3$. Total surface area significantly related to level of self-compactability of concrete. It can be said that total surface of bubbles was the principle factor on flowability and self-compactability improvement for self-compacting concrete with entrained air.

CHAPTER 5

CONCLUSIONS

The purpose of this study was to develop Air-enhanced Self-Compacting Concrete with lower unit cement content than conventional SCC and to clarify the mechanism of air-enhanced self-compactability. The conclusions of this study were summarized as follows:

1. Higher W/C with VA was not sufficient to reduce internal friction in mortar. Although friction was slightly reduced by increasing W/C to be 45%, s/m could not be increased more than 45%. Accordingly, self-compactability could not reach the level of self-compactability of the conventional SCC. That was why air-SCC was to be developed.
2. Simple standard mixing method could not entrain air bubble enabling enhance self-compactability. Although reduction in friction by ball bearing effect was existed, the stability of entrained air was very low. Improvement of both self-compactability and stability of air was necessary.
3. A new type of mixing procedure in which water was divided and AE agent was poured at the end of the mixing enabled air-enhanced self-compactability. Accordingly, fine aggregate content can be increased up to 55% resulting in effective reduction in unit cement content in mix proportion. Low cost self-compacting concrete with low unit cement content by employing entrained air called Air-enhanced self-compacting concrete (AirSCC) has been achieved.
4. The average diameter of the air bubbles enhancing self-compactability was smaller than that of air bubbles entrained with simple mixing method. The larger total surface area of the entrained air enhanced self-compactability which could be produced by water dividing or Last adding AE mixing method. Total surface area was the main factor on level of self-compactability of AirSCC.

REFERENCES

- 1) Okamura, H., and Ozawa, K., (1995). "Mix-design of self-compacting concrete," Concrete Library of JSCE, 25, 107-120.
- 2) Japanese Society of Civil Engineer (1998). "Recommendation for Self-Compacting Concrete,".
- 3) Okamura, H., Maekawa, K., and Ozawa, K., (1993) "High Performance Concrete", Gihodo Publishing, JSCE.
- 4) Ouchi, M., et.al., (1999). A simple evaluation method for interaction between coarse aggregate and mortar's particles in self-compacting concrete, *Transaction of The Japan Concrete Institute*
- 5) Okamura, H., Ouchi, M. (2003) "Self-Compacting Concrete," *Journal of Advanced Concrete Technology*, ACT Vol. 1, No. 1, pp. 5-15.
- 6) Sakata et al. (2003). Study on New Viscosity Agent for Combination Use Type of Self-Compacting Concrete, *Journal of Advanced Concrete Technology*, ACT Vol. 1, No. 1, pp. 37-41.
- 7) Bartos, P., (1992) "Fresh Concrete, Properties and Tests," Elsevier Science Publishers BV.
- 8) Attachaiyawuth, A., and Ouchi., M. (2014). "Effect of entrained air on mitigation of reduction in interaction between coarse aggregate and mortar during deformation of self-compacting concrete at fresh stage." *Proceeding of the Japan Concrete Institute, JCI* , Vol. 36, No. 1, 1444-1449.
- 9) Attachaiyawuth, A., Kazunori, T., Sovannsathya, R. and Ouchi., M. (2015). "Air-enhanced self-compactability of fresh concrete with effective mixing method." *Proceeding of the Japan Concrete Institute, JCI*, Vol, 37, No., 1 1069-1074.
- 10) Treval, C. Powers (1968). "The Properties of Fresh Concrete," John Wiley and Sons, Inc.
- 11) A. M. Neville (1996). "Properties of Concrete," John Wiley and Sons, Inc.